

Halo® Exterra®

HALO®

ADVANCED GRAPHITE INSULATION SYSTEM

INSTALLATION GUIDE



1.0 – PRECAUTIONS FOR HANDLING, STORAGE & INSTALLATION..... 5
 1.1 - JOBSITE STORAGE AND HANDLING 5
 1.2 - INSTALLATION..... 5

2.0 – USEFUL TOOLS & MATERIALS 6

3.0 – PRODUCT DESCRIPTION 7
 3.1 - FEATURES 7
 3.3 - AVAILABLE SIZES 7

4.0 – APPLICATION 8

5.0 - INSTALLATION 8
 5.1 - FASTEN EXTERRA TO THE WALL SUBSTRATE..... 8
 5.2 - FRAMED WALLS WITH WOOD SHEATHING 9
 5.3 - FRAMED WALLS WITHOUT WOOD SHEATHING..... 9
 5.4 - CONCRETE OR MASONRY WALLS..... 11
 5.5 - TRANSITIONS 11
 5.5.1 - FOUNDATION TRANSITION 11
 5.5.2 - ROOF TRANSITION..... 12
 5.6 - SEALING JOINTS AND FASTENER PENETRATIONS..... 12
 5.6.1 - PENETRATIONS 13
 5.6.2 - OPENINGS 15
 5.7 - CLADDING..... 17
 5.8 - CAVITY WALLS..... 17

6.0 – FASTENING EXTERRA 18
 6.1 - TYPICAL FASTENER TYPES..... 18
 6.2 - TYPICAL NAILING PATTERNS OVER WOOD SHEATHING & OPEN STUD ASSEMBLY 18
 6.3 - NAILING PATTERNS FOR PREFABRICATED WALL ASSEMBLIES 25
 6.4 - RECOMMENDED FASTENER LENGTHS..... 30
 6.5 - OVER CONCRETE OR MASONRY WALLS 31
 6.4 - CAVITY WALLS..... 31

7.0 - INSPECTION & REPAIRS..... 32

8.0 - CLADDING OVER EXTERRA..... 33
 8.1 - CLADDING OVER EXTERRA WITHOUT WOOD STRAPPING 33
 8.2 - CLADDING OVER EXTERRA WITH WOOD STRAPPING 33

9.0 - AIR BARRIER..... 35
 9.1 - ROOF/CEILING TRANSITION 35
 9.2 - WALL PERIMETER AND RIM BOARDS..... 36
 9.3 - FOUNDATION..... 36
 9.4 - PENETRATIONS 37
 9.5 - INTERIOR ELECTRICAL RECEPTACLES..... 37



HALO® EXTERRA® EXTERIOR RIGID INSULATION

TABLE OF CONTENTS

10.0 - EXAMPLE CAD DETAILS	38
10.1 - FLANGED WINDOW INSTALLED AGAINST WOOD SHEATHING	39
10.2 - FLANGED WINDOW INSTALLED AGAINST EXTERRA	40
10.3 - ROOF TRANSITION.....	41
10.4 - TYPICAL WALL ASSEMBLY	42
10.5 - FLOOR TRANSITION.....	43
10.6 - FOUNDATION TRANSITION	44

INSTALLATION GUIDE

For more information, or to contact a Halo representative, visit our website at www.BuildWithHalo.com and click "Contact Us".

This manual will be updated regularly. Current updates will be available at www.BuildWithHalo.com.



1.0 – PRECAUTIONS FOR HANDLING, STORAGE & INSTALLATION

Precautionary measures taken in packaging, storage, transportation and installation of Halo products can help minimize the potential for damage to the products.

1.1 - JOBSITE STORAGE AND HANDLING

Halo products should be protected from reflective sunlight or prolonged solar exposure.

Always keep stored Halo products tarped or covered to protect from weather. Do not use a clear plastic covering film. If possible, store indoors.

1.2 - INSTALLATION

Until cladding is installed over Exterra the following recommendations will help ensure installed Halo products are restored to its original dimensions in the event of thermal expansion, and minimize damage due to reflective sunlight or prolonged solar exposure.

- Remove or cover the surface that is casting a reflection on installed Halo products, or shield the affected Halo products.
- Cover Exterra if left exposed for more than 30 days. Faded printing on Halo laminates is normal and will not degrade the Halo properties.
- Ensure all butt joints are tightly fitted. "5.6 - SEALING JOINTS AND FASTENER PENETRATIONS" on page 12.
- Immediately tape seal or temporarily cover all joints of inside corners until tape sealant is applied. Edges of Subterra products installed on subgrades and adjacent to Exterra should also be immediately covered until proper sealant method is applied along the perimeter between Exterra and Subterra.

For more information contact your local Halo representative or e-mail info@buildwithhalo.com.



HALO® EXTERRA® EXTERIOR RIGID INSULATION

2.0 – USEFUL TOOLS & MATERIALS

Recommended for sealing joints, penetrations, perimeter edges and flashing details

- Halo Sheathing Tape
- Perma R Products Sheathing Tape
- Vapor barrier blue or red Tuck Tape,
- 3M peel and stick membrane,
- Blueskin flashing tape and
- Expandable foam.

Recommended for fastening or gluing

- weather resistive construction glue, such as PL 300,
- plastic cap nails,
- roofing nails with at least 1/2" diameter washers,
- cap staples or
- wood screws with metal roof washers.

When fastening to metal studs use self-drilling screws with at least 1" diameter metal washers.

Additional tools:

- Hammer and cordless drill
- Utility knife and straight edge

3.0 – PRODUCT DESCRIPTION

3.1 - FEATURES

Exterra is a rigid foam sheathing insulation faced with a polypropylene laminate that is perforated to allow the sheathing to breathe. The insulation is made with graphite polystyrene (GPS) which is expanded polystyrene infused with graphite particles. Insulation made with GPS provides up to 18% more R-value than conventional EPS.



3.2 - BENEFITS

When installed as exterior insulation Exterra offers the following functional benefits.

- Provides continuous insulation, which reduces thermal breaks.
- Increases the R-value of wall assemblies that cannot be achieved with cavity insulation alone.
- Acts as a water-resistive barrier - eliminates the need for house wrap when the joints are sealed and taped. This reduces air leakage and ensures moisture transmission through the cladding will drain to the outside.
A house wrap is not required with Exterra for thicknesses 9/16" or greater.
- Contains perforations, which allow Exterra to breathe.
Because Exterra is breathable, a vapor barrier may be required for the wall assembly.
Exterra remains breathable with thicknesses up to 2 inches.
- Reduces heat gains in warm climates when an air gap is provided between Exterra and the cladding (applicable only where Exterra is available with a reflective laminate).

3.3 - AVAILABLE SIZES

Available in 4ft x 8ft sheets, 1/2", 9/16", 5/8", 1", 1.5" and 2" thickness. Custom sizes and thicknesses are available. Contact your local Halo representative for availability.



HALO® EXTERRA® EXTERIOR RIGID INSULATION

4.0 – APPLICATION

Suitable for use for new construction and existing buildings, Halo Exterra is designed to completely insulate exterior above-grade walls in residential, multi-residential, commercial, and industrial buildings while providing a breathable water-resistive barrier.

5.0 - INSTALLATION

The following illustrations are typical for the installation of Halo Exterra as interior insulation.

Installation may vary depending on project specific requirements. Before starting, make sure all installation complies with local building code requirements.

Exterra consists of a perforated laminate allowing the sheathing to breath. Therefore, an additional vapor barrier may be required for the wall assembly.

NOTE: Where Exterra is available with a reflective or white laminate on one side of the insulation it is recommended that Exterra is installed with these laminates facing the exterior.

5.1 - FASTEN EXTERRA TO THE WALL SUBSTRATE

Exterra is fastened directly to the wall substrate or framing members, such as wood sheathing, wood or steel stud framing, concrete or masonry walls.

Attach Exterra at corners, as a minimum, to the substrate or framing members. A minimal number of fasteners is required to tack Exterra sheets in place – the attachment of cladding, or strapping will fully secure Exterra sheets.

Place Exterra against the wall substrate either vertically or horizontally. For tall walls installing vertically is preferable.

For information on fastener information see “6.0 – FASTENING EXTERRA” on page 18.



5.2 - FRAMED WALLS WITH WOOD SHEATHING

Fasten Exterra directly over the wood sheathing. For existing framed wall buildings remove the cladding material and house wrap to expose the wood sheathing.

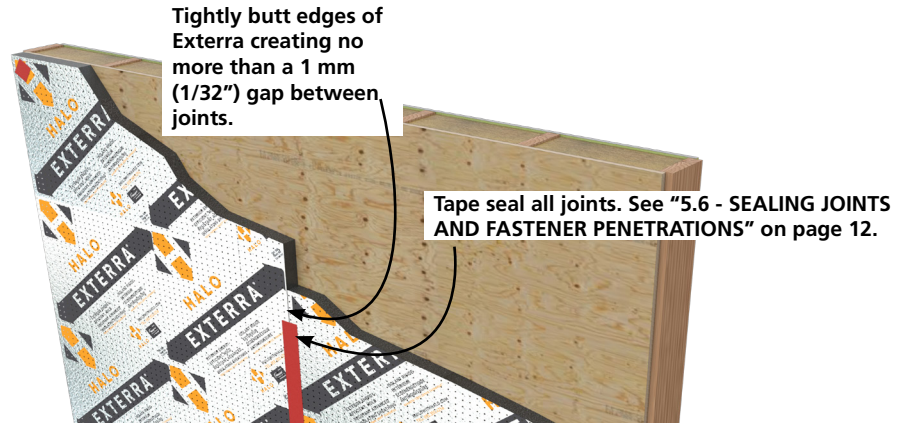

For information on fastening Exterra over wood sheathing see "6.0 – FASTENING EXTERRA" on page 18.

5.3 - FRAMED WALLS WITHOUT WOOD SHEATHING

Exterra can be installed directly over wall studs. Since Exterra is not structural sheathing the walls will require bracing, per local building codes.

5.3.1 - DIAGONAL BRACING

Some examples of typical bracing include metal T-straps, or 1x4 wood let-in. Typical corner bracing includes wood sheathing at the corners, such as OSB or plywood.

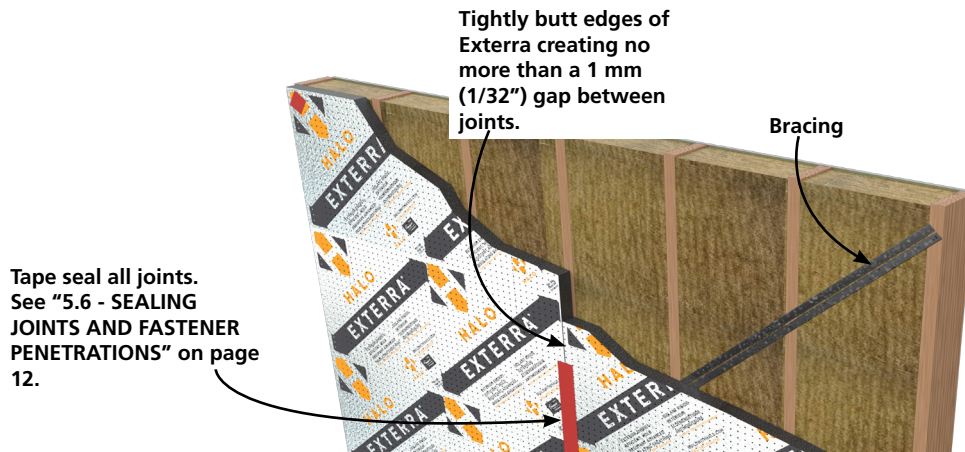

HALO® EXTERRA® EXTERIOR RIGID INSULATION

5.3.2 - WOOD SHEATHING BRACING

Exterra is installed over the entire home after the structural sheathing are installed as corner bracing. The panels add thickness to the framed wall at the corner regions so Exterra will be thinner over the sheathing than areas without sheathing. This ensures the exterior face of Exterra remains flush along the walls.

INSTALLATION GUIDE

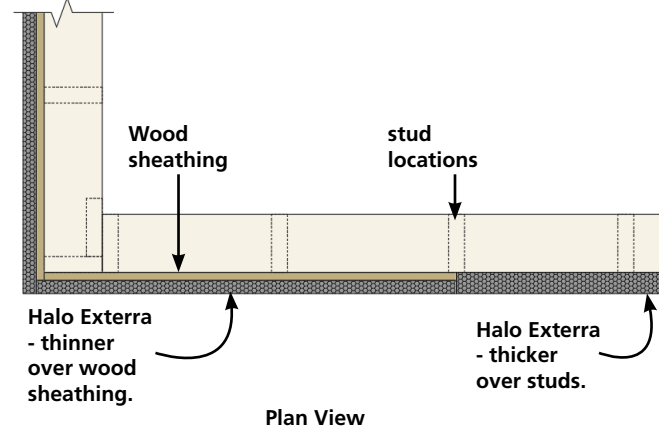
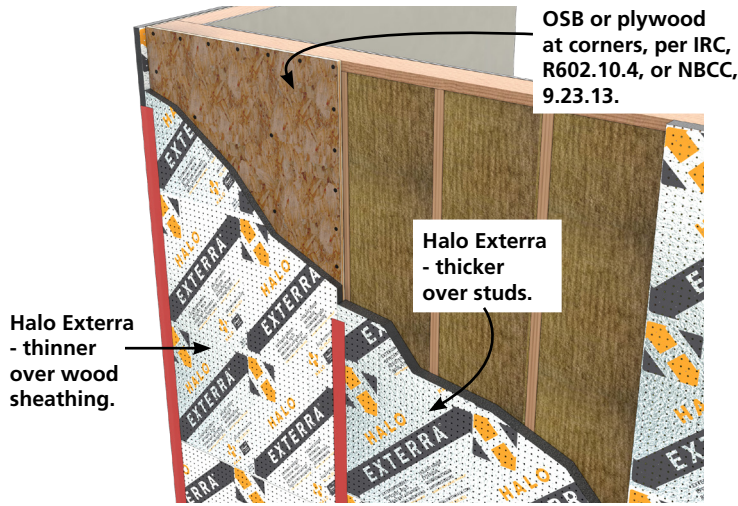

5.3.3 - INSULATED WOOD SHEATHING BRACING

Insulated wood structural panels, such as Zip System R-Sheathing, used as corner bracing offers continuous insulation built into the structural sheathing. In this case, Exterra is not required over the structural panel but should be thick enough to match the thickness of the structural sheathing and its underlying insulation layer throughout the entire wall.

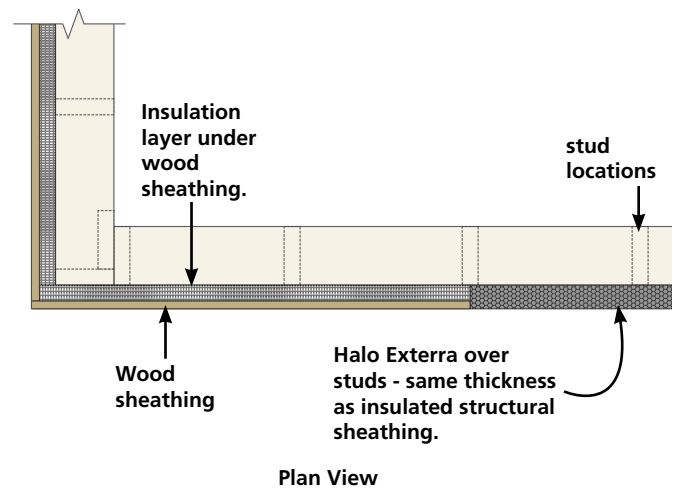
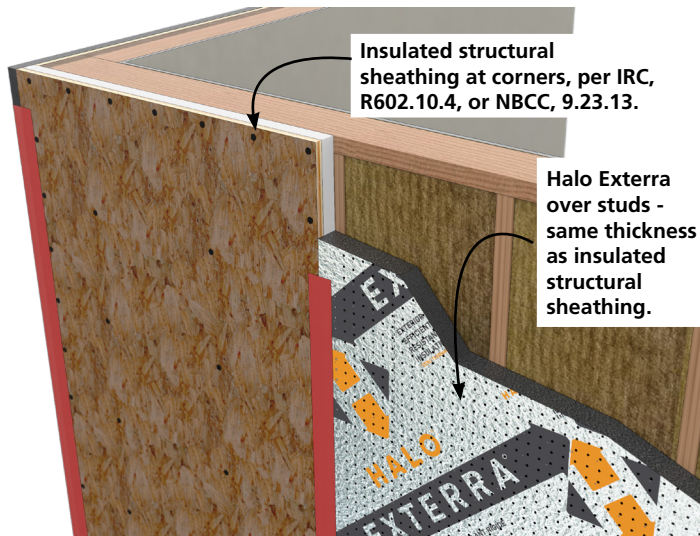

For more information on fastening Exterra direct to wall studs and corner bracing see "6.0 – FASTENING EXTERRA" and online Technical Bulletin No.12, respectively.

5.4 - CONCRETE OR MASONRY WALLS

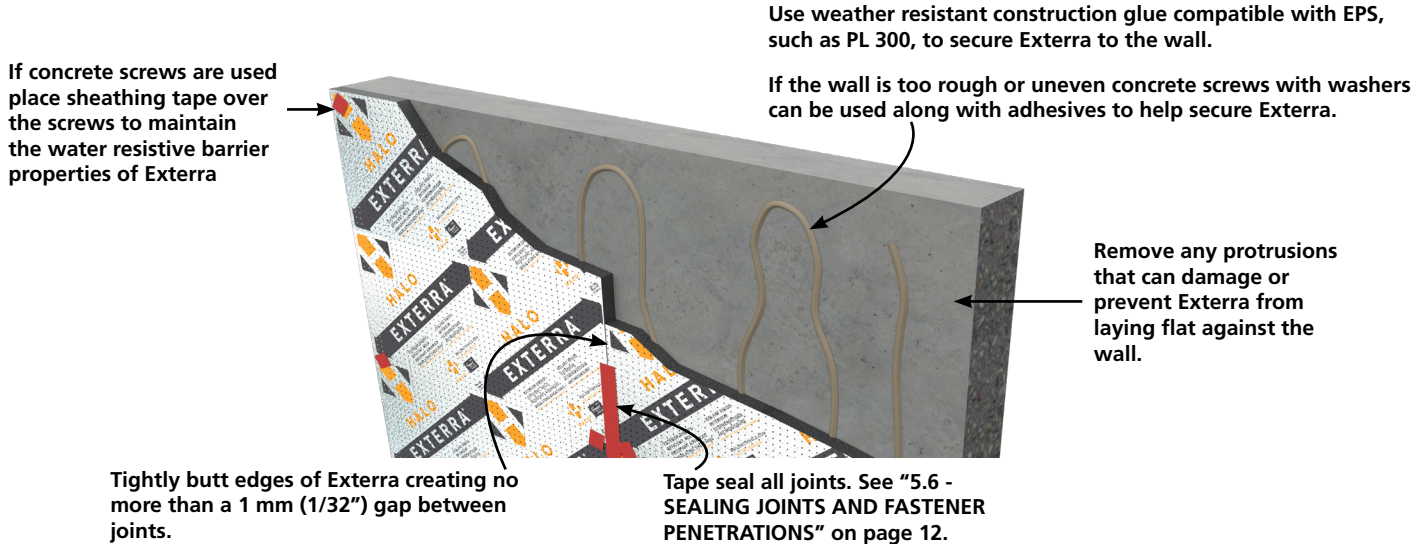

5.5 - TRANSITIONS

There are different methods to ensuring Exterra performs as a water-resistive barrier, and properly drains moisture to the exterior.

The following illustrations are detail examples for transitions the foundation and roof level.

5.5.1 - FOUNDATION TRANSITION

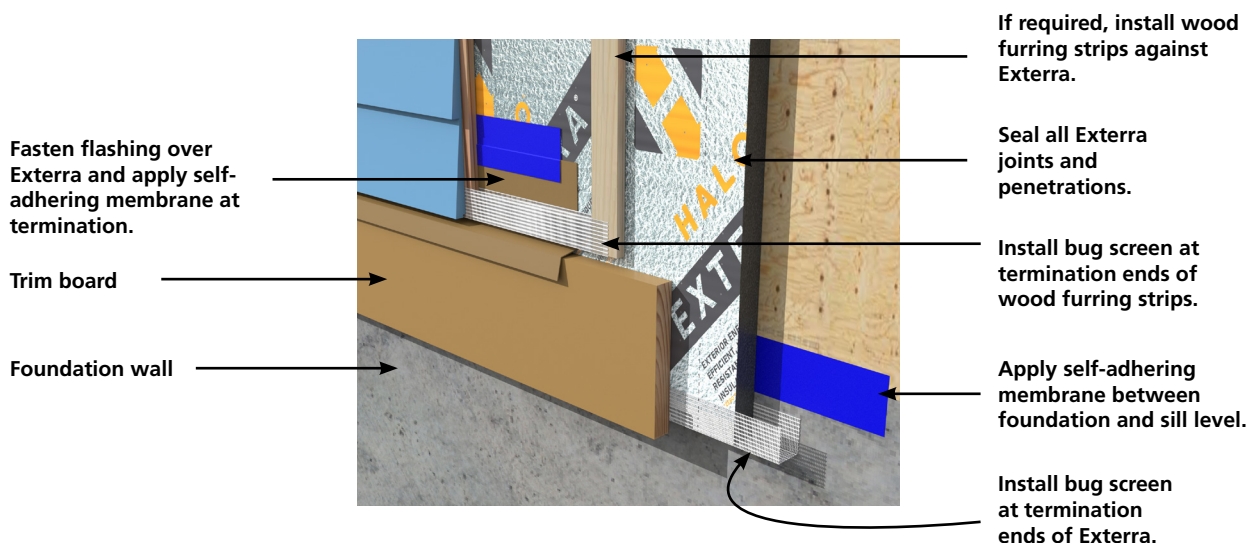

5.5.2 - ROOF TRANSITION

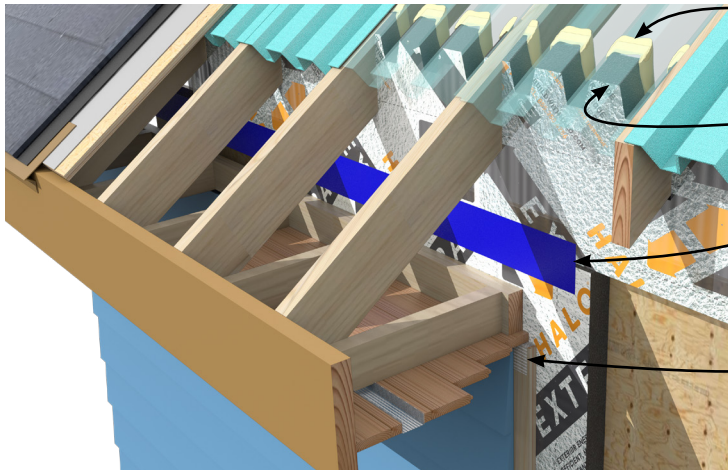

- Spray foam.
- Cut Exterra to underside of the roof baffles. Apply spray foam at termination.
- Seal all Exterra joints and penetrations.
- Install bug screen at termination ends of wood furring strips.

INSTALLATION GUIDE

5.6 - SEALING JOINTS AND FASTENER PENETRATIONS

Joints between Exterra boards, and fastener penetrations, should be sealed. This will maintain the water-resistant barrier properties of Exterra, especially when Exterra is intended to be used as the water-resistant barrier, in lieu of a separate membrane such as house wrap.

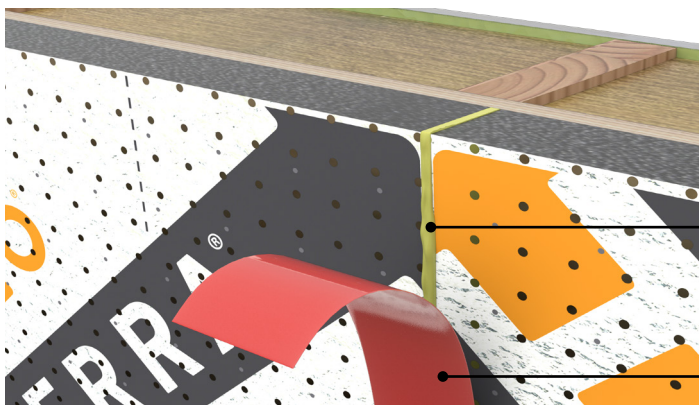

- Joints should be tight and snug. Foam fill and tape over joints with gaps 1/16" or larger.
- Seal all joints with sheathing or flashing tape.

Place sheathing tape over fasteners to maintain the water resistant barrier properties of Exterra

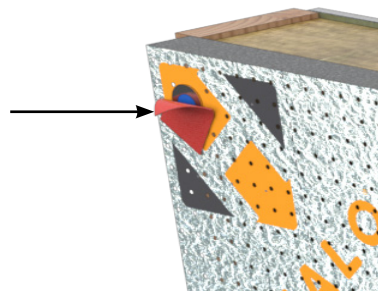

5.6.1 - PENETRATIONS

Measure and cut Exterra to suit the rough opening for penetrations. Exterra boards can be cut using a utility knife.

The following illustrations provide a typical example of addressing proper drainage and insulation around a penetration.

Step 1: Cut a rough opening.

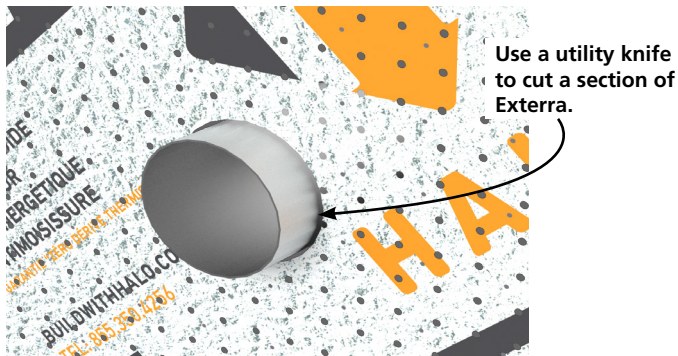

Step 2: Apply spray foam to fill gaps.

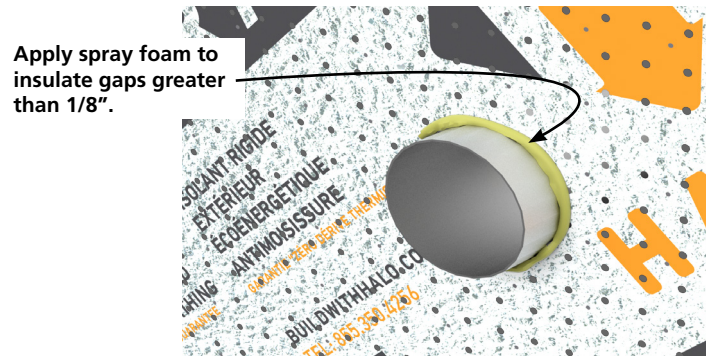

Step 3: Apply self-adhesive membrane at bottom half.

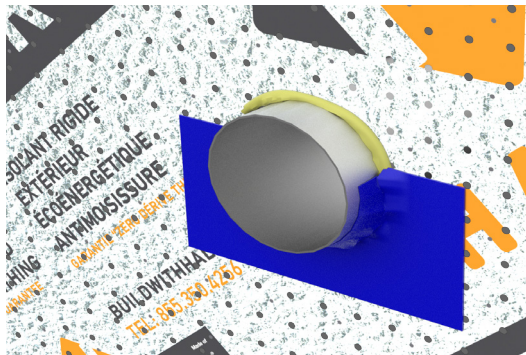

Step 4: Apply self-adhesive membrane at top half.

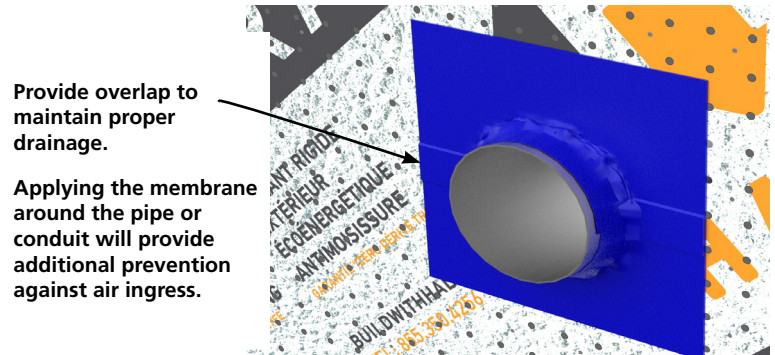

Step 5: Apply sheathing tape.

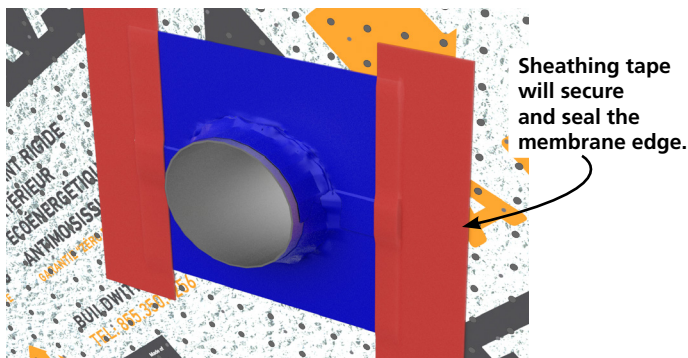

Step 6: Install trim block.

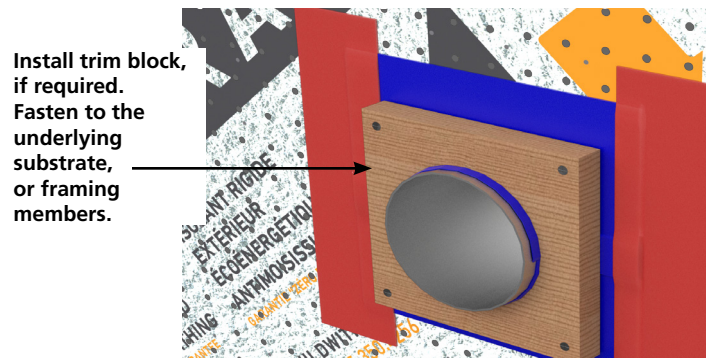

HALO® EXTERRA® EXTERIOR RIGID INSULATION

5.0 - INSTALLATION cont'd

Step 7: Install flashing.

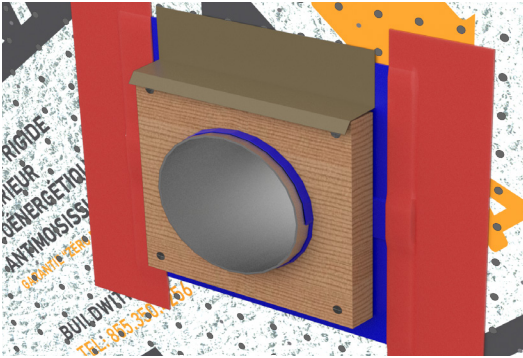

Step 8: Apply sheathing tape to seal edge of membrane and flashing.

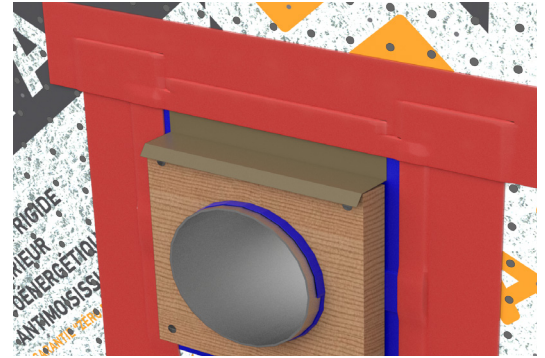

Step 9: Fasten cover to trim block.

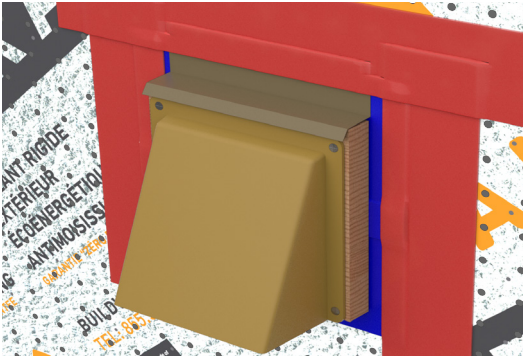

INSTALLATION GUIDE



5.6.2 - OPENINGS

The following illustrations provide a typical example of addressing proper drainage and insulation around a flanged window. For additional window opening details refer to "10.0 - EXAMPLE CAD DETAILS" on page 38.

Step 1: After cutting a section of Exterra to match the rough opening, install a self-adhering flashing membrane at the sill.

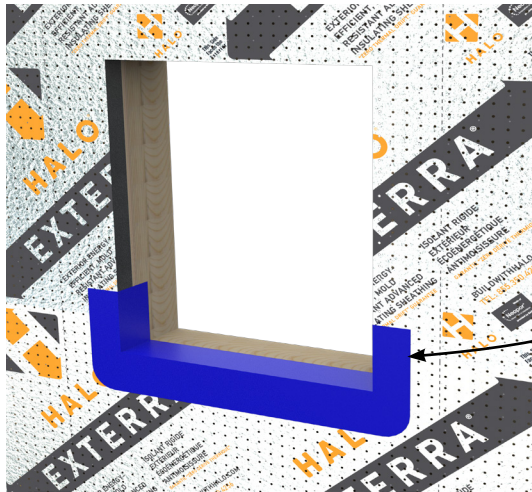

Install a vertical section of the membrane a minimum of 8" up the jamb.

Step 2: Install a self-adhering membrane along the length of the jam.

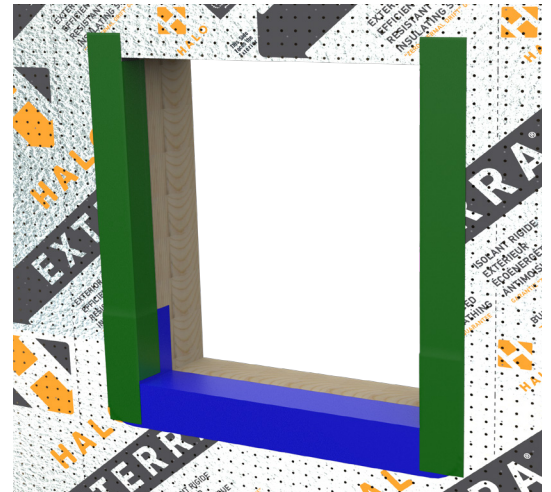

Step 3: Install the flanged window and fasten to the substrate.

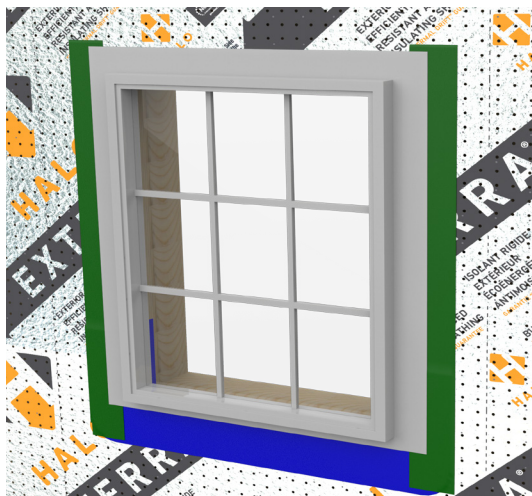

Step 4: Install a self-adhering membrane along the length of the jam over the flanges.

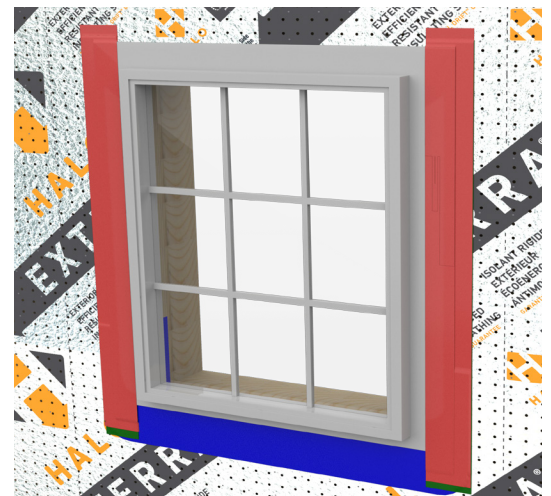

Step 5: Install the head flashing.

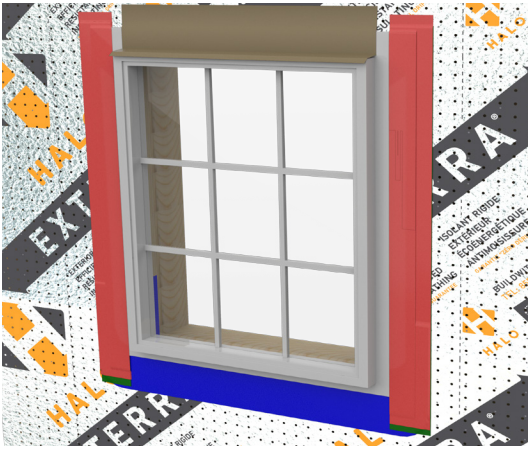

Step 6: Install a self-adhering membrane over the flashing.

Apply sheathing tape lapped over the membrane.

Self-adhering membrane should completely lap the membranes at the jambs.



Step 7: if required, install furring strips around the opening.

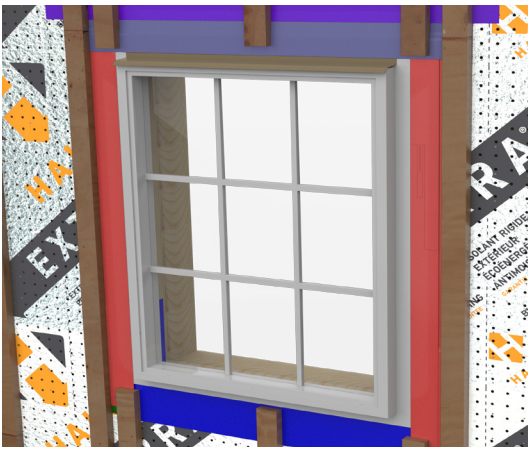

Step 8: Install trim boards and fasten to the furring strips or substrate.

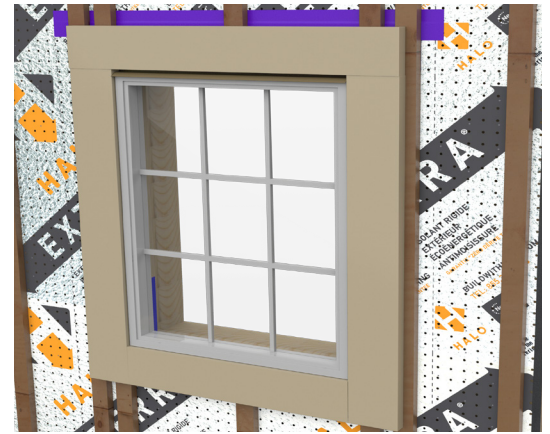

Step 9: Install cladding, as required.

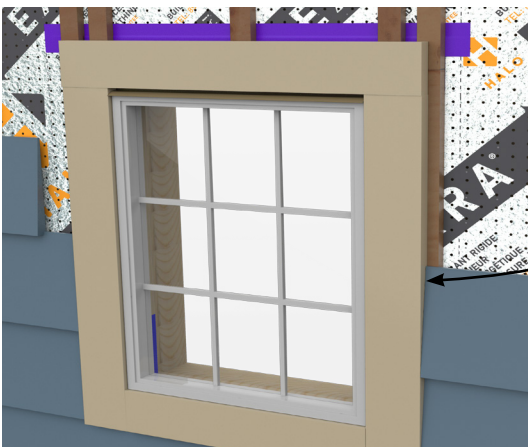

Apply a compatible sealant between cladding and trim boards.

Apply spray foam between rough opening and window.

Step 10: Apply spray foam.



5.7 - CLADDING

Cladding and wood strapping can be installed directly over Exterra with the use of fasteners.

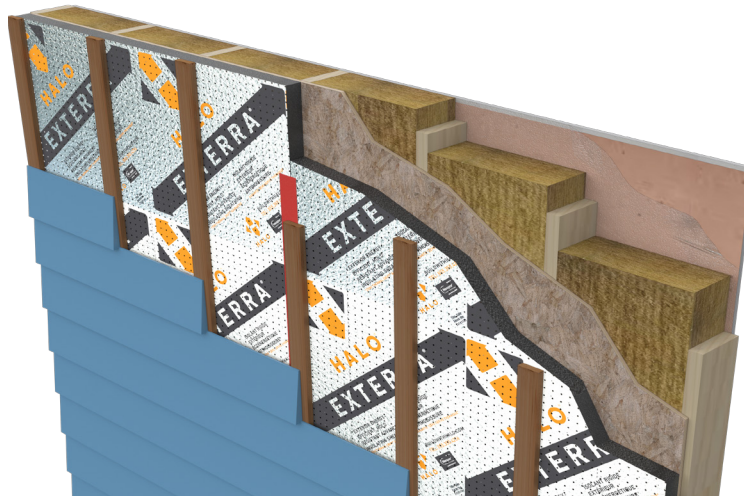

Fasten cladding to the substrate, or if required to the wood furring strips. See "8.0 - CLADDING OVER EXTERRA" on page 33.

5.8 - CAVITY WALLS

Fasten Exterra directly to the wall substrate using appropriate fasteners.

There are a number of available brick ties designed to be compatible for foam sheathing. Below is a list of compatible brick ties.

Fasteners for brick ties must penetrate the Exterra layer and at least 3/4" into the wall substrate.

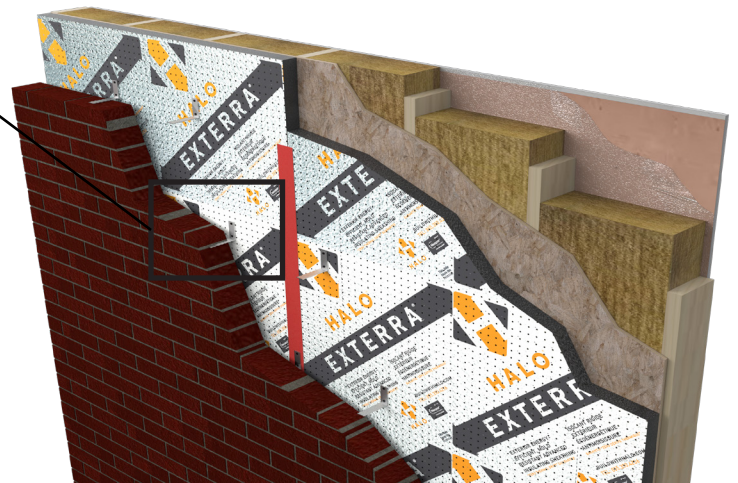
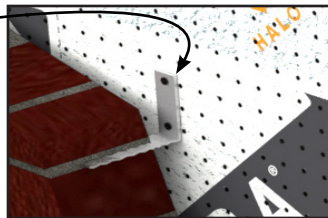

- Slotted Stud Tie, Fero Corp., ferocorp.com
- Pos-i-Tie, Heckmann Building Products, heckmannbuildingprods.com
- X-Seal Anchor, Hohmann & Barnard, H-b.com
- Dur-O-Wal Veneer Anchors, Dayton Superior, daytonsuperior.com.



HALO® EXTERRA® EXTERIOR RIGID INSULATION

6.0 – FASTENING EXTERRA

This section is a guide to fastening:

- Exterra to wall substrate
- Cladding or wood strapping over Exterra.

Exterra is not structural so a minimal number of fasteners is required to tack Exterra sheets in place – the attachment of cladding, strapping, and housewrap will fully secure Exterra boards.

6.1 - TYPICAL FASTENER TYPES

Fasteners with washer types are recommended to secure Exterra boards with the top of the fasteners flush to the surface of Exterra boards.

Typical fastener types include, but are not limited to:

- Plastic cap nails,
- roofing nails with at least ½" diameter washers,
- cap staples,
- or wood screws with metal roof washers.

When fastening to metal studs use screws with at least 1" diameter metal washers.

6.2 - TYPICAL NAILING PATTERNS OVER WOOD SHEATHING & OPEN STUD ASSEMBLY

The following provides suggested nailing patterns when installing Exterra over wood sheathing or direct to wood studs. Guide lines printed on the Exterra boards can be used to locate studs and fastening points.

To maintain the water resistive barrier and continuous insulation properties all fasteners and joints should be covered with sheathing tape. In addition, large gaps should be foam filled prior to covering with sheathing tape. For more information refer to "5.6 - SEALING JOINTS AND FASTENER PENETRATIONS" on page 12.

For information on recommended fastener lengths refer to "6.4 - RECOMMENDED FASTENER LENGTHS" on page 30.

6.2.1 - OVER WOOD SHEATHING

Fastening into wood studs is not required when installing Exterra over wood sheathing - the wood sheathing will provide sufficient backing for fasteners.



HALO® EXTERRA® EXTERIOR RIGID INSULATION

6.0 - FASTENING EXTERRA cont'd

Exterra can be placed either horizontally or vertically without the need to stagger vertical joints in a running bond pattern. However, offsetting the joints in Exterra to that of the wood sheathing is recommended to minimize air gaps and improve air tightness.



Offset horizontal and vertical joints between Exterra and wood sheathing when possible.

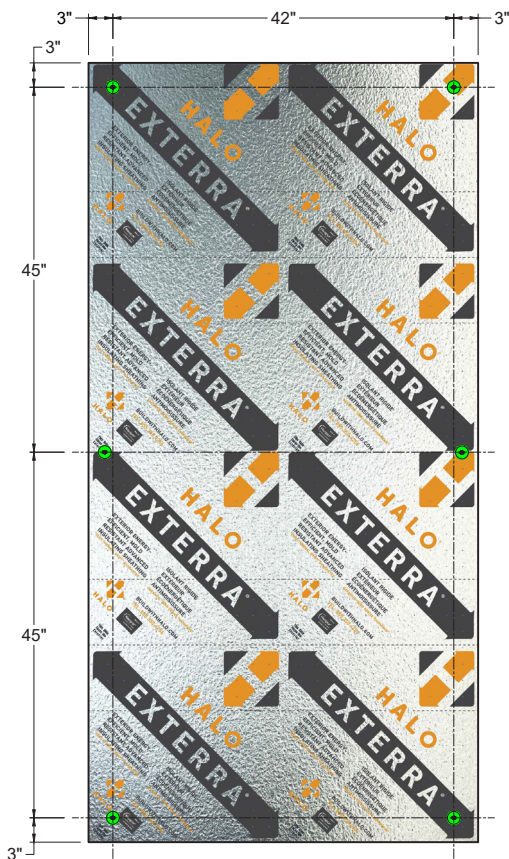

Nailing pattern - Vertical placement against wood sheathing (4'x8' Exterra board shown)

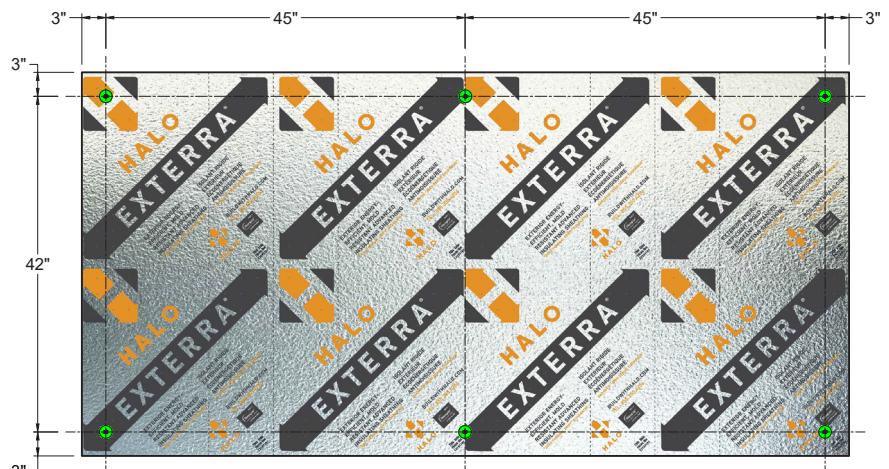

Nailing pattern - Horizontal placement against wood sheathing (4'x8' Exterra board shown)

TYPICAL NAILING PATTERNS OVER WOOD SHEATHING



6.2.2 - OVER OPEN STUD ASSEMBLY

Exterra boards are fastened direct to the wood studs in an open stud wall assembly.

Since Exterra boards are non-structural, the stud wall assembly must be properly braced, as required by building codes or structural specifications.

Exterra can be placed either horizontal or vertically. The vertical joints of Exterra boards should rest fully or halfway on a stud to ensure proper fastening to the stud. [show image]

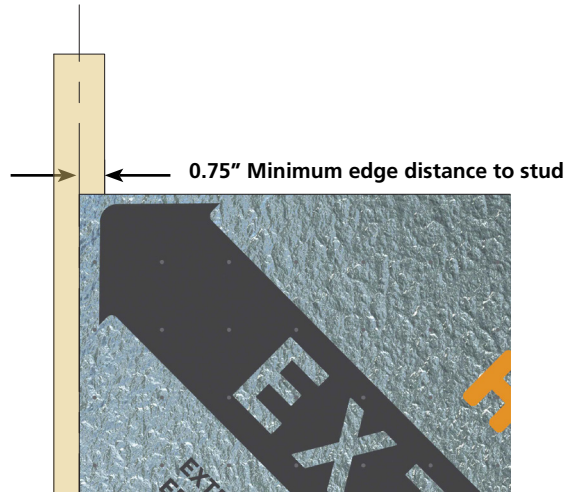

HALO® EXTERRA® EXTERIOR RIGID INSULATION

6.0 - FASTENING EXTERRA cont'd

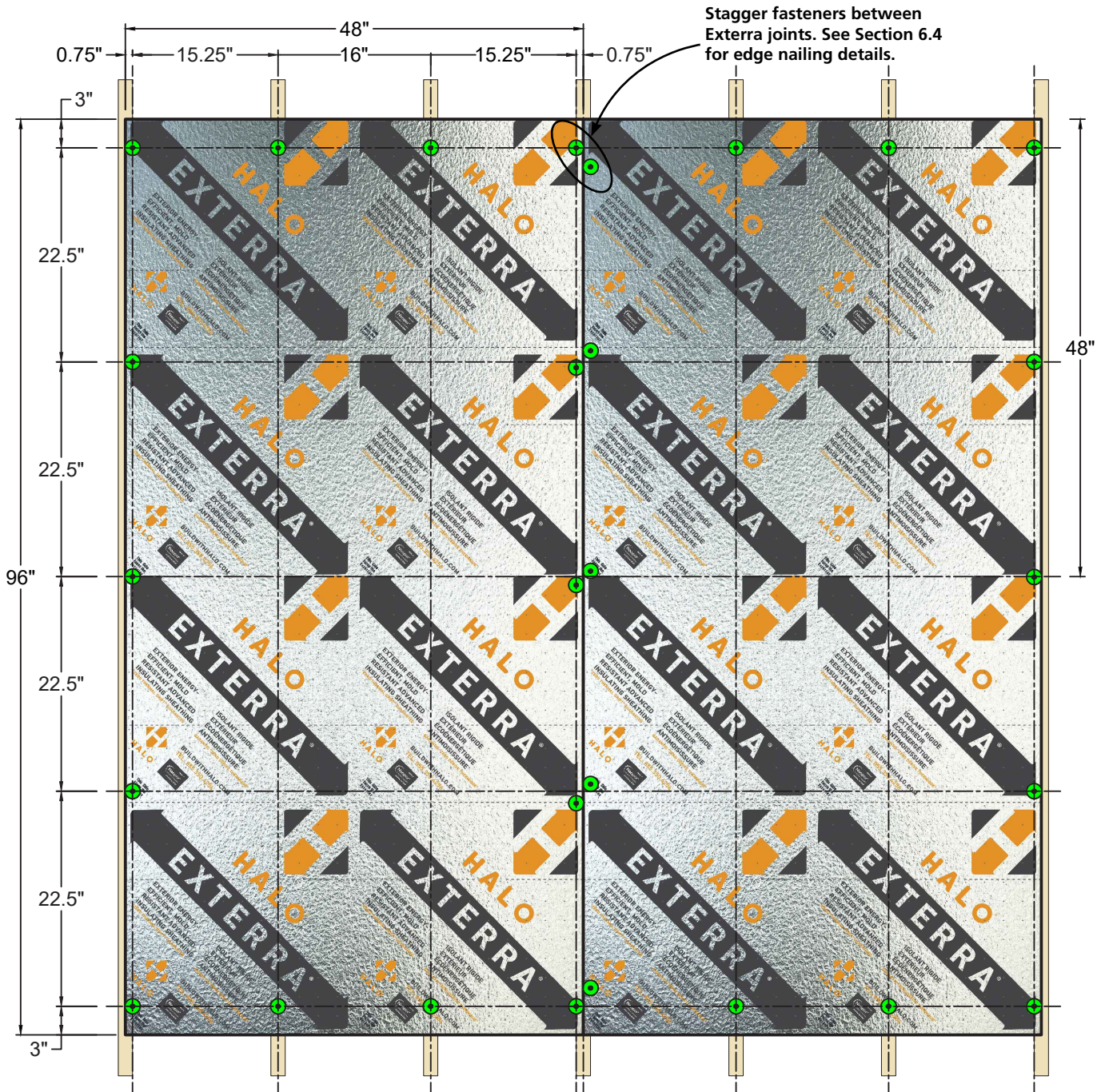

INSTALLATION GUIDE

Nailing pattern - Vertical placement against 16" wood stud spacing (4'x8' Exterra boards shown). Use printed guidelines on Exterra boards to approximate vertical spacing of fasteners.

TYPICAL NAILING PATTERN OVER OPEN STUD ASSEMBLY VERTICAL INSTALLATION OVER 16" STUD SPACING



ADVANCED GRAPHITE INSULATION SYSTEM

BuildWithHalo.com | REV2.031722 | 2-21

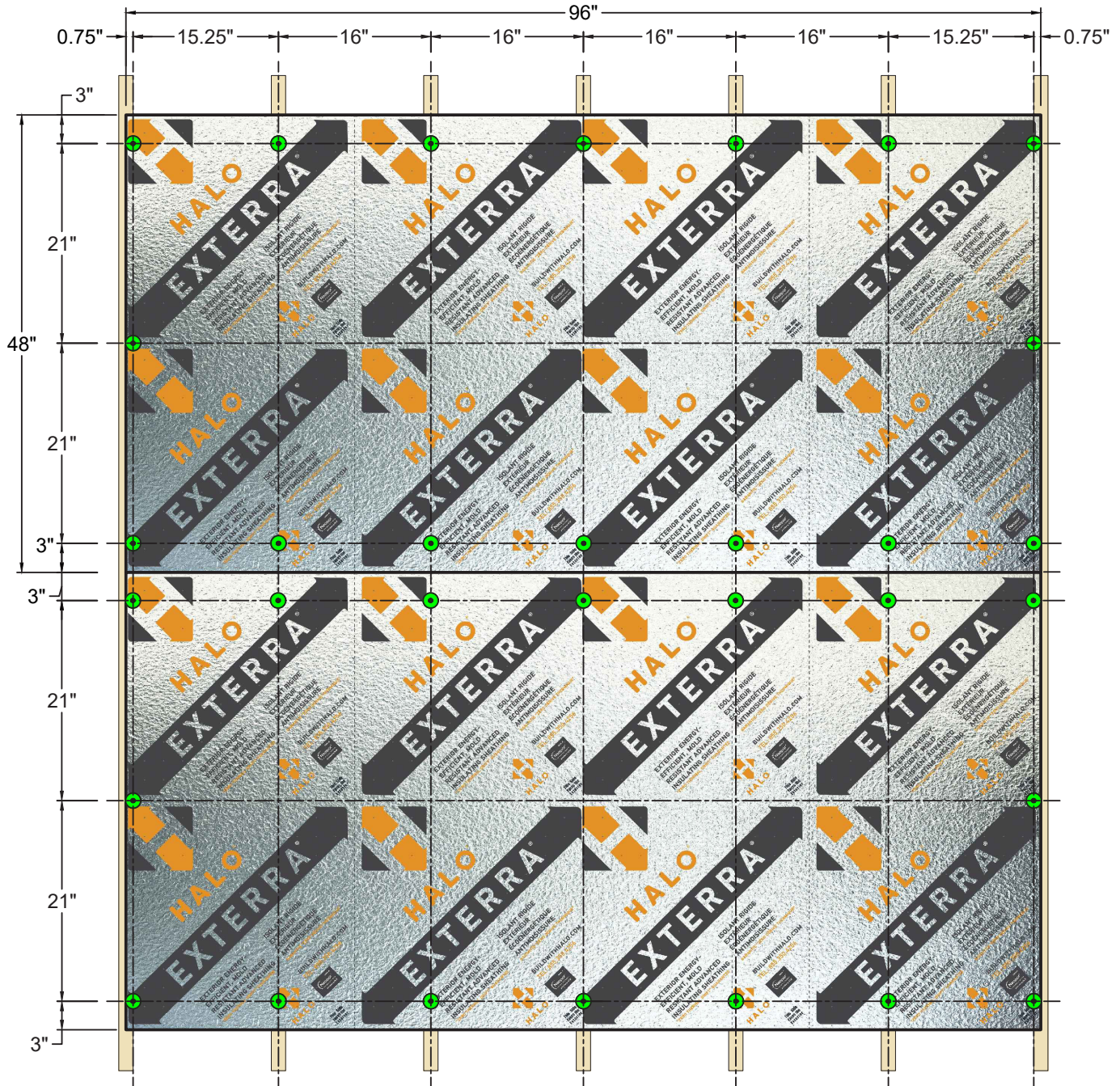

Nailing pattern - Horizontal placement against 16" wood stud spacing (4'x8' Exterra boards shown). Printed guidelines on Exterra boards can be used to locate studs.

TYPICAL NAILING PATTERN OVER OPEN STUD ASSEMBLY HORIZONTAL INSTALLATION OVER 16" STUD SPACING



HALO® EXTERRA® EXTERIOR RIGID INSULATION

6.0 - FASTENING EXTERRA cont'd

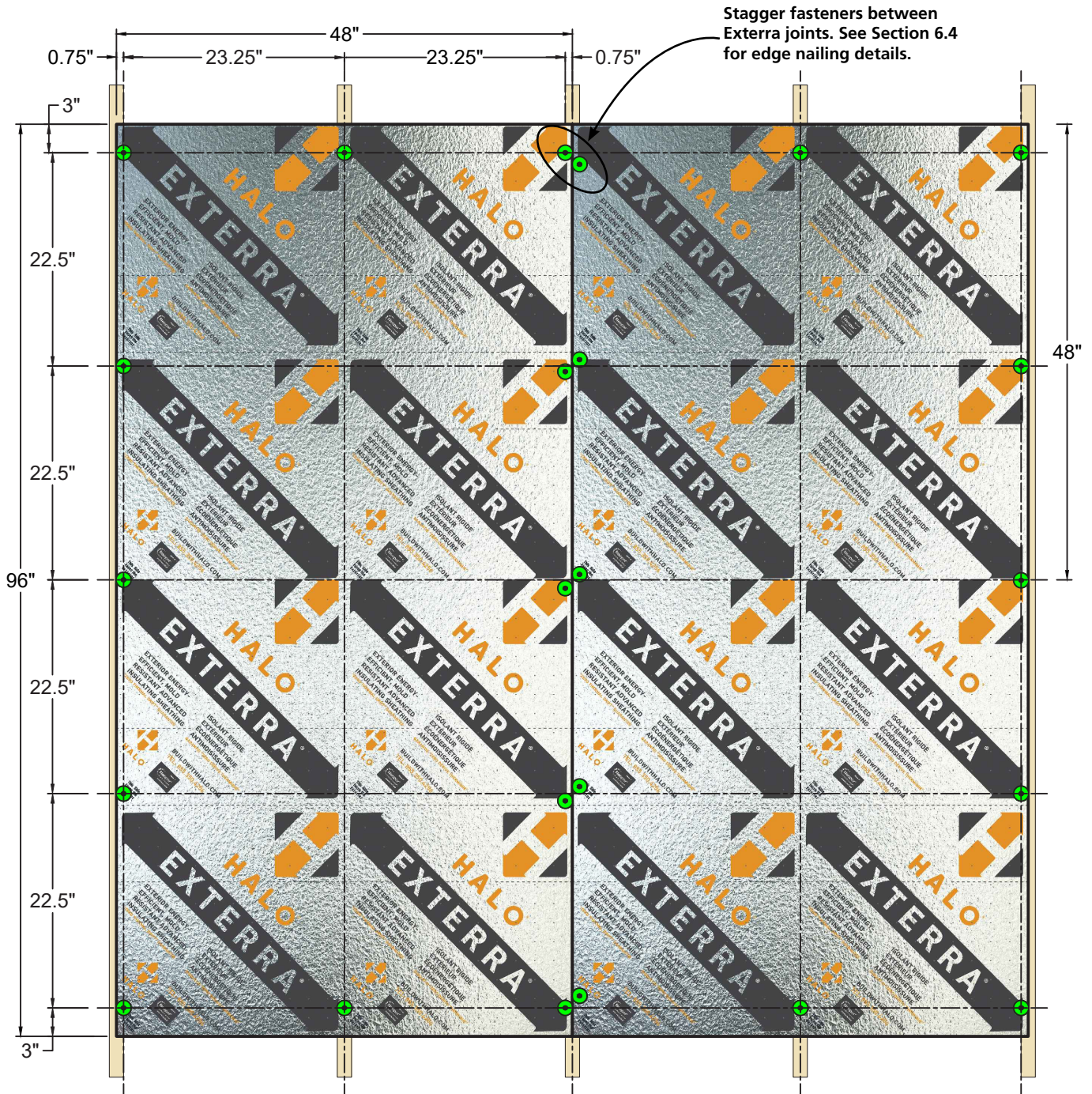

INSTALLATION GUIDE

Nailing pattern - Vertical placement against 24" wood stud spacing (4'x8' Exterra boards shown). Use printed guidelines on Exterra boards to approximate vertical spacing of fasteners.

TYPICAL NAILING PATTERNS OVER OPEN STUD ASSEMBLY VERTICAL INSTALLATION OVER 24" STUD SPACING



ADVANCED GRAPHITE INSULATION SYSTEM

BuildWithHalo.com | REV2.031722 | 2-23

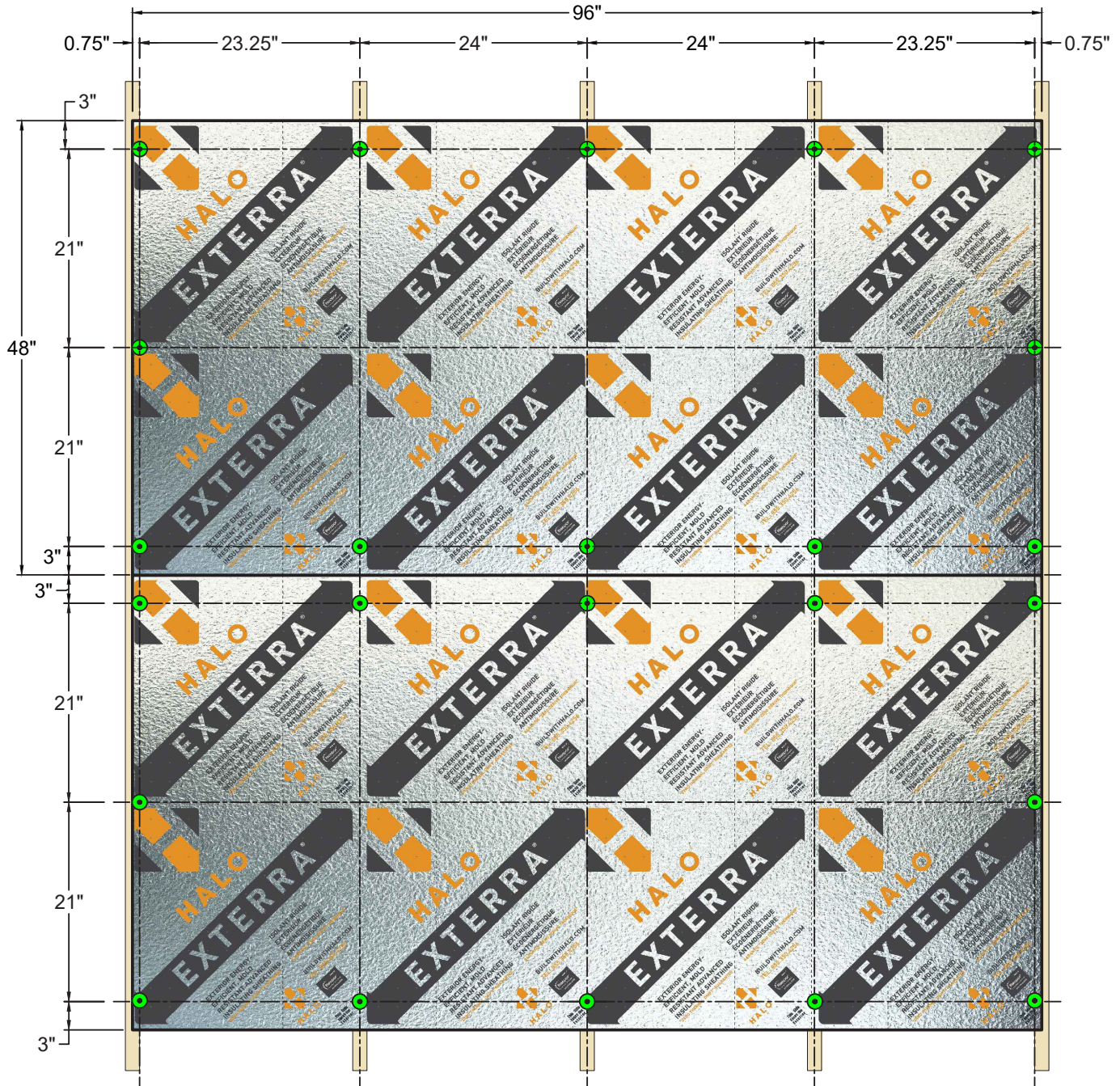

Nailing pattern - Horizontal placement against 24" wood stud spacing (4'x8' Exterra boards shown). Printed guidelines on Exterra boards can be used to locate studs.

TYPICAL NAILING PATTERNS OVER OPEN STUD ASSEMBLY HORIZONTAL INSTALLATION OVER 24" STUD SPACING



6.3 - NAILING PATTERNS FOR PREFABRICATED WALL ASSEMBLIES

When Exterra is installed in a factory-built wall system additional fasteners are required to secure Exterra boards due to handling and transportation of the prefabricated wall assembly.

Since Exterra boards are non-structural, the wall assembly must be properly braced, as required by building codes or structural specifications.

Before cladding is installed over Exterra inspect the Exterra boards for any visible signs of damage, and to ensure all taped joints and penetrations are properly adhered to Exterra.

For information on inspecting and repairing installed Exterra boards, refer to "7.0 - INSPECTION & REPAIRS" on page 32.

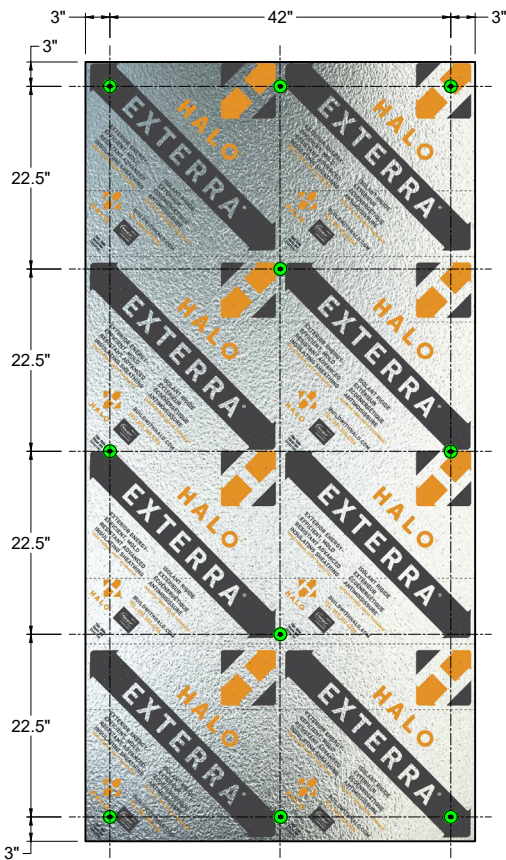

Nailing pattern - Vertical placement against wood sheathing (4'x8' Exterra board shown)

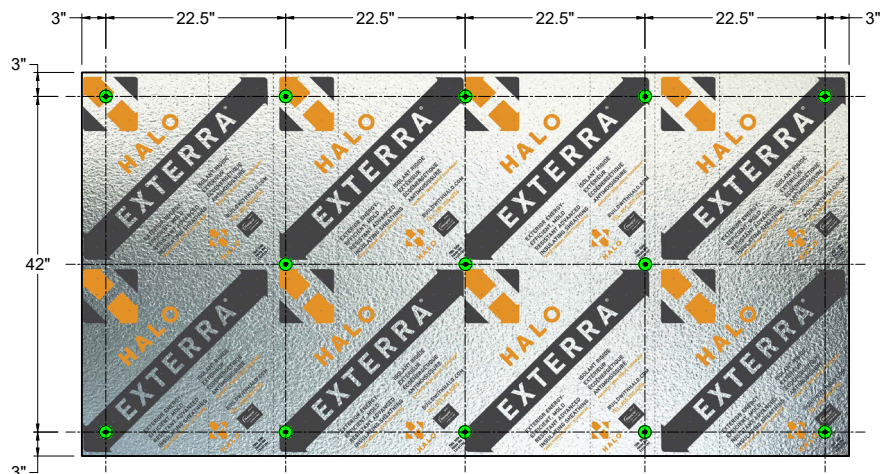

Nailing pattern - Horizontal placement against wood sheathing (4'x8' Exterra board shown)

TYPICAL NAILING PATTERNS OVER WOOD SHEATHING PREFABRICATED WALL ASSEMBLIES



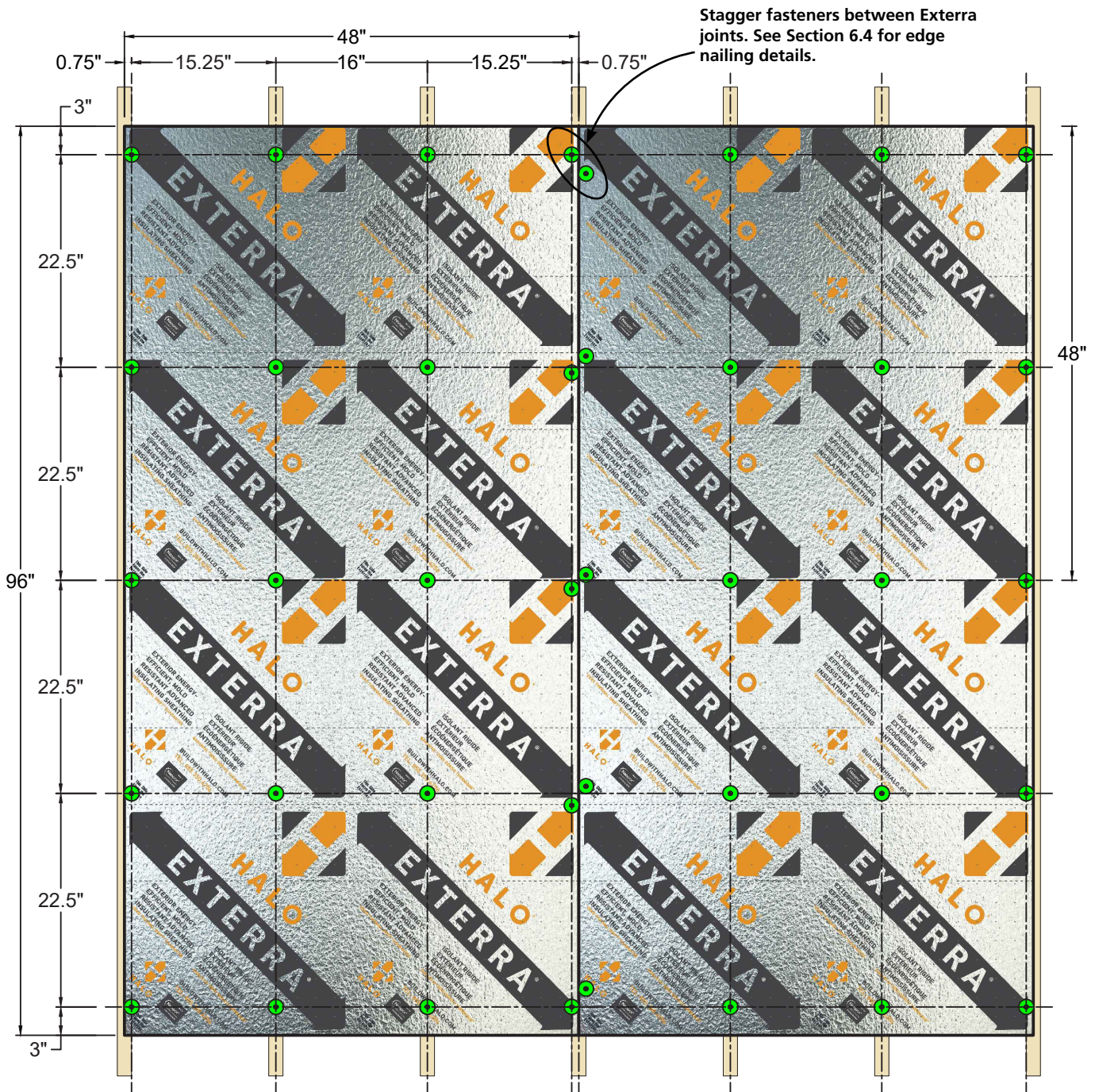

Nailing pattern - Vertical placement against 16" wood stud spacing (4'x8' Exterra boards shown). Use printed guidelines on Exterra boards to approximate vertical spacing of fasteners.

**PREFABRICATED WALL ASSEMBLIES
TYPICAL NAILING PATTERN OVER OPEN STUD ASSEMBLY
VERTICAL INSTALLATION OVER 16" STUD SPACING**



HALO® EXTERRA® EXTERIOR RIGID INSULATION

6.0 - FASTENING EXTERRA cont'd

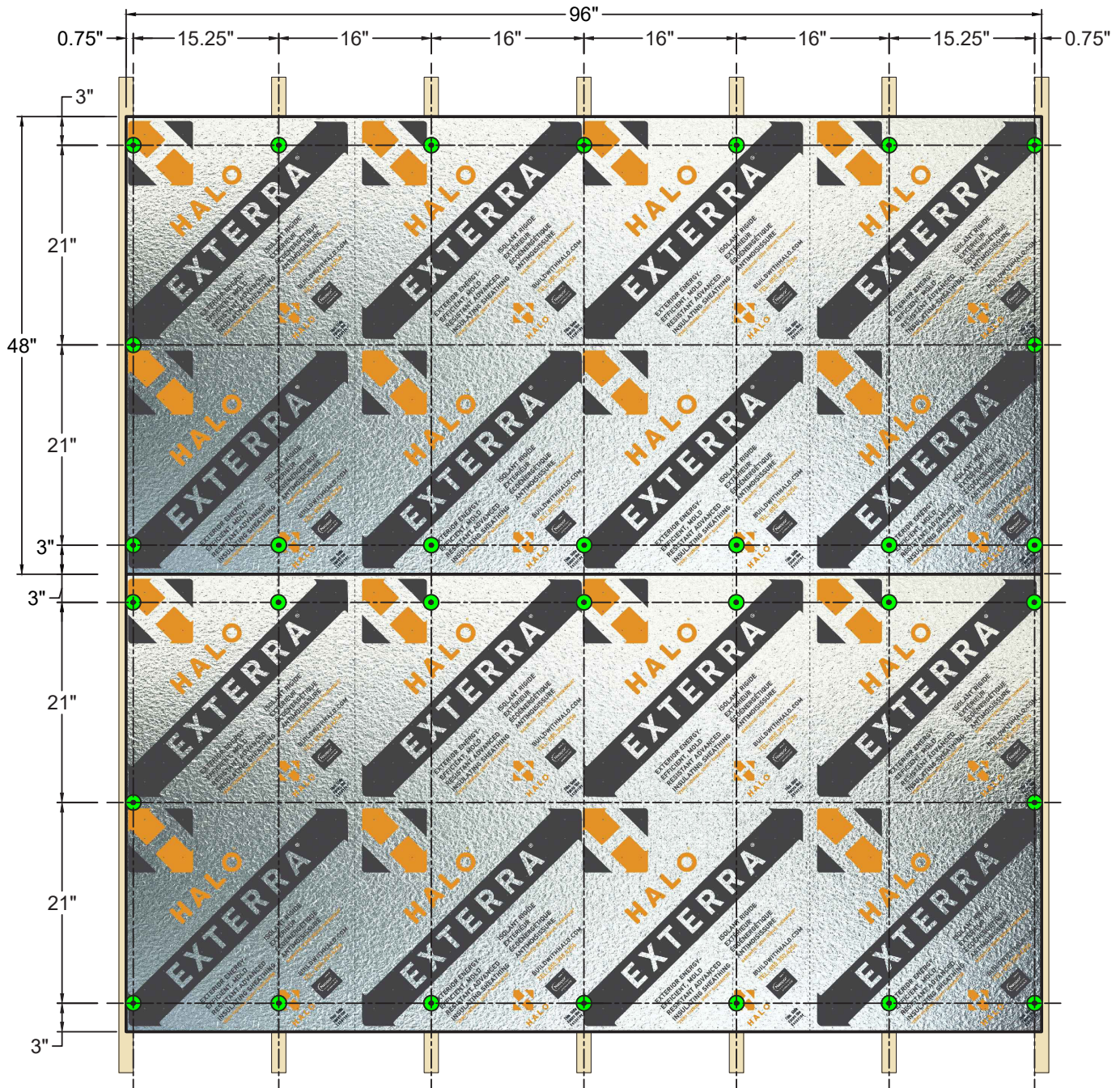

INSTALLATION GUIDE

Nailing pattern - Horizontal placement against 16" wood stud spacing (4'x8' Exterra boards shown). Printed guidelines on Exterra boards can be used to locate studs.

**PREFABRICATED WALL ASSEMBLIES
TYPICAL NAILING PATTERN OVER OPEN STUD ASSEMBLY
HORIZONTAL INSTALLATION OVER 16" STUD SPACING**



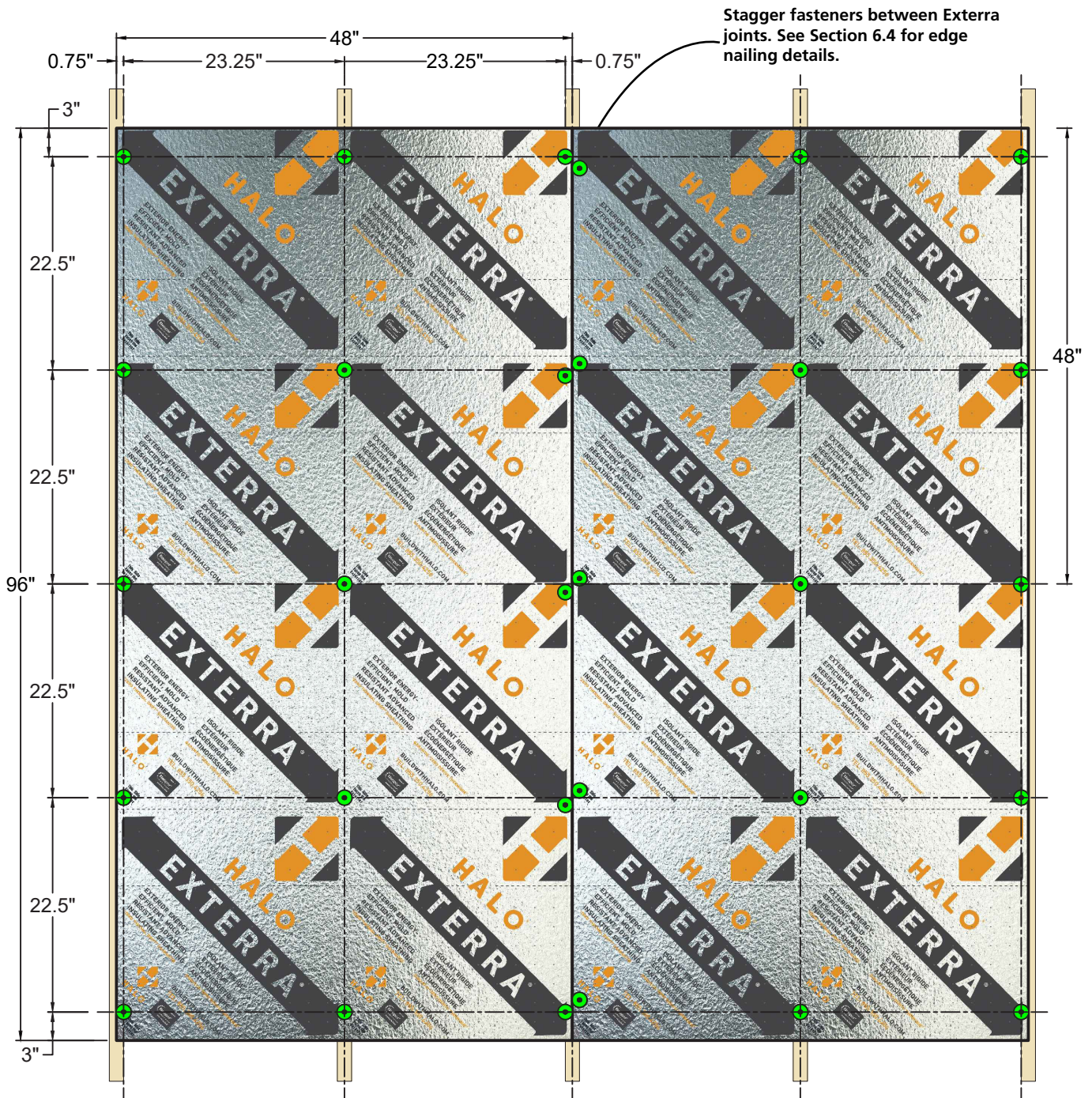

Nailing pattern - Vertical placement against 24" wood stud spacing (4'x8' Exterra boards shown). Use printed guidelines on Exterra boards to approximate vertical spacing of fasteners.

**PREFABRICATED WALL ASSEMBLIES
TYPICAL NAILING PATTERN OVER OPEN STUD ASSEMBLY
VERTICAL INSTALLATION OVER 24" STUD SPACING**



HALO® EXTERRA® EXTERIOR RIGID INSULATION

6.0 - FASTENING EXTERRA cont'd

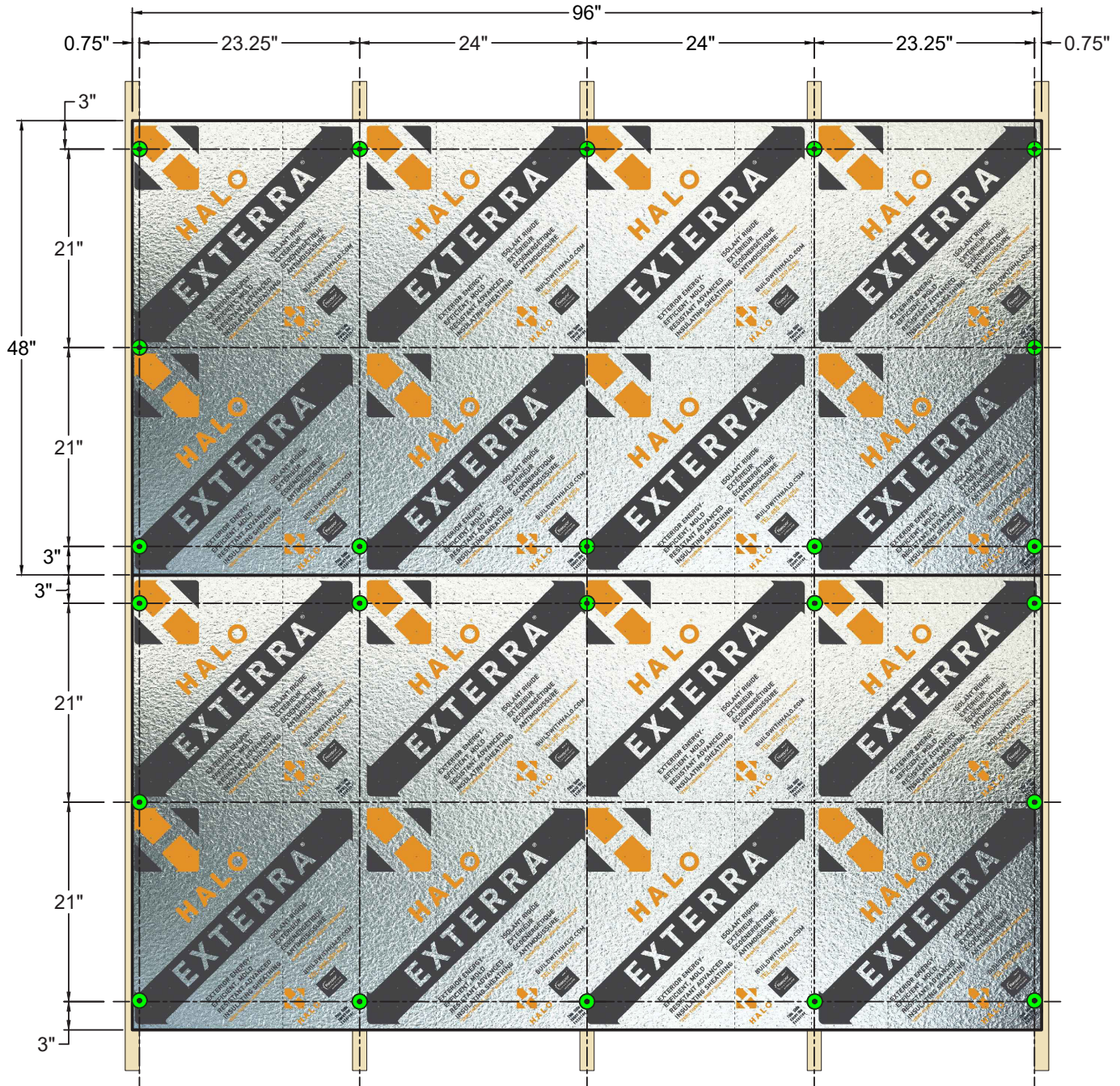

INSTALLATION GUIDE

Nailing pattern - Horizontal placement against 24" wood stud spacing (4'x8' Exterra boards shown). Printed guidelines on Exterra boards can be used to locate studs.

PREFABRICATED WALL ASSEMBLIES TYPICAL NAILING PATTERN OVER OPEN STUD ASSEMBLY HORIZONTAL INSTALLATION OVER 24" STUD SPACING



ADVANCED GRAPHITE INSULATION SYSTEM

BuildWithHalo.com | REV2.031722 | 2-29

6.4 - RECOMMENDED FASTENER LENGTHS

6.4.1 - OVER WOOD SHEATHING

Fasteners should be long enough to penetrate Exterra and completely through the wood sheathing substrate.

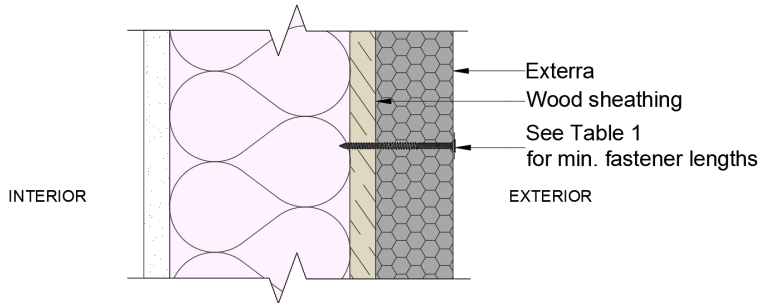

Table 1: Exterra Fastened to Wood Sheathing

Exterra Thickness	Minimum Fastener Lengths		
	1/2" Wood Sheathing	5/8" Wood Sheathing	3/4" Wood Sheathing
9/16" or 5/8"	1 1/8"	1 1/4"	1 3/8"
1"	1 1/2"	1 5/8"	1 3/4"
1 1/2"	2"	2 1/8"	2 1/4"
2"	2 1/2"	2 5/8"	2 3/4"

6.4.2 - OVER WOOD STUD ASSEMBLY

Fasteners should be long enough to penetrate Exterra and at least 3/4" into the framing studs or blocking between studs.

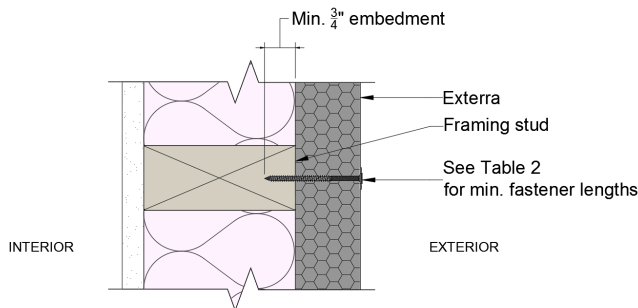
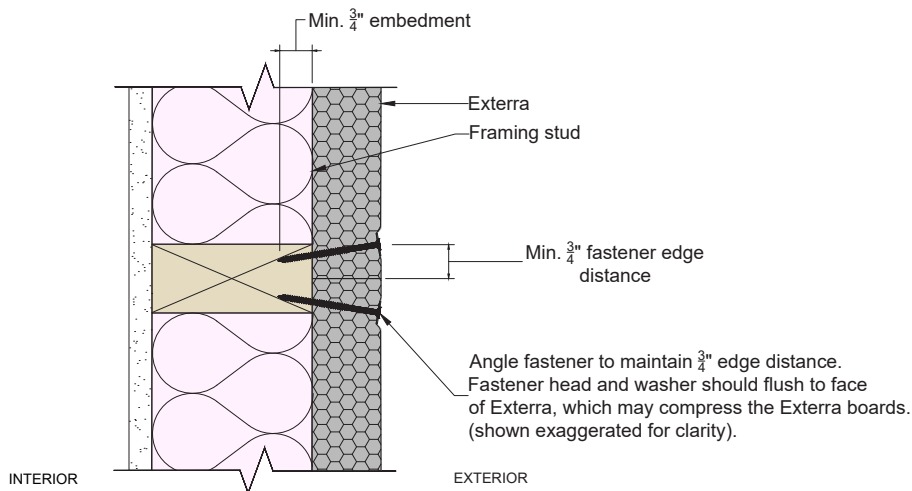

Table 2: Exterra Fastened Direct to Framing Studs

Exterra Thickness	Minimum Fastener Lengths
9/16" or 5/8"	1 3/8"
1"	1 3/4"
1 1/2"	2 1/4"
2"	2 3/4"

To maintain minimum 3/4" edge distance at vertical joints angle the fasteners.



6.5 - OVER CONCRETE OR MASONRY WALLS

Use weather resistant construction glue compatible with expanded polystyrene, such as PL 300, to secure Exterra sheets to the wall. If the wall is too rough or uneven concrete screws with washers can be used along with adhesives to help secure the sheets.

If concrete screws are used place sheathing tape over the screws to maintain the water resistive barrier properties of Exterra

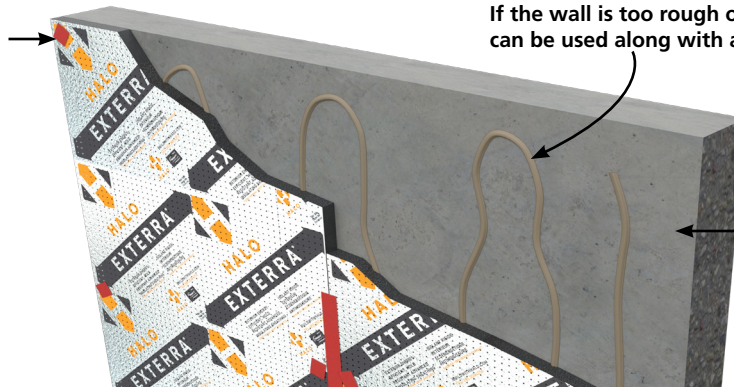

Use weather resistant construction glue compatible with EPS, such as PL 300, to secure Exterra to the wall.

If the wall is too rough or uneven concrete screws with washers can be used along with adhesives to help secure Exterra.

Remove any protrusions that can damage or prevent Exterra from laying flat against the wall.

6.4 - CAVITY WALLS

For cavity walls, Exterra will either be placed over wood, concrete or masonry substrates. Refer to Sections 5.8, 6.2 to 6.5 for appropriate fastening requirements.



HALO® EXTERRA® EXTERIOR RIGID INSULATION

7.0 - INSPECTION & REPAIRS

Exterra is designed to be durable and flexible. However, inspecting the condition of installed Exterra boards prior to the attachment of cladding or strapping will ensure Exterra performs as designed.

Inspect installed Exterra boards sufficiently in advance of cladding or strapping placement to ensure

- taped seams are not broken
- joints, penetrations and perimeter are properly sealed
- damaged areas are marked and properly repaired.

In most cases repairing damaged Exterra boards simply requires tape sealing over the damaged area. If the foam and laminate are damaged then removing the damaged section and replacing with a new section will be required.

INSTALLATION GUIDE

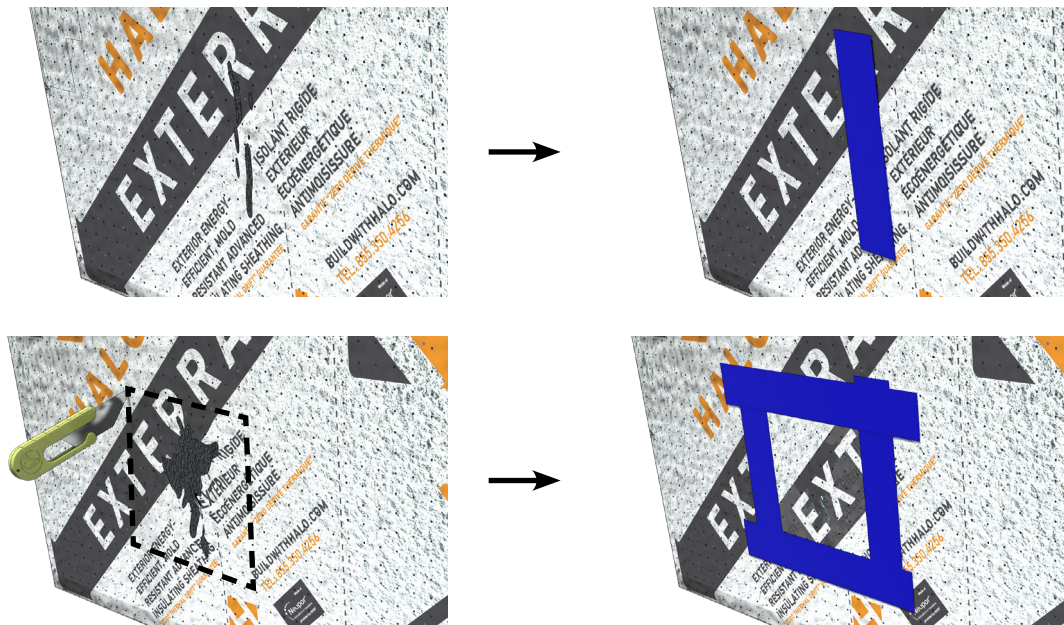

8.0 - CLADDING OVER EXTERRA

This section is a guide to fastening cladding or wood strapping over Halo Exterra.

NOTE: Where Exterra is available with a reflective or white laminate on one side of the insulation it is recommended that Exterra is installed with these laminates facing the exterior.

8.1 - CLADDING OVER EXTERRA WITHOUT WOOD STRAPPING

When cladding is attached without wood strapping, nails or screws used to attach cladding directly over Exterra should penetrate Exterra and completely through the wood sheathing. The thickness of the wood sheathing should be structurally adequate to resist the lateral and pull-out loads the cladding may be subjected to. Check with your local cladding supplier to confirm.

In cases where wood sheathing is not present, or will not provide adequate strength, the fasteners should be fastened into the framing members. The nails or screws should penetrate Exterra and at least 1" into the framing studs, or blocking between framing studs.

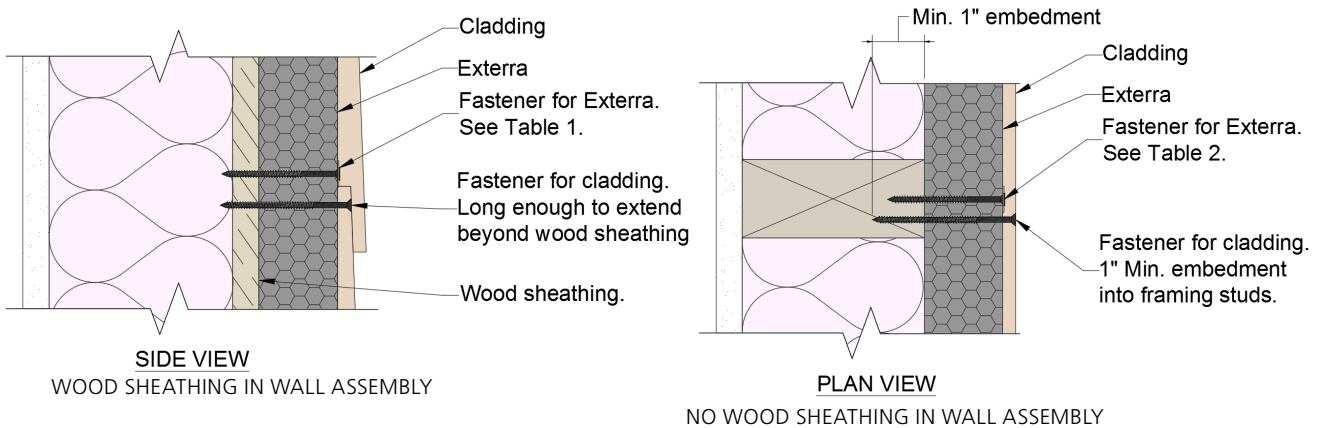

8.2 - CLADDING OVER EXTERRA WITH WOOD STRAPPING

When using wood strapping over Exterra, the cladding will be fastened to the strapping.

1. Wood Strapping Size:
Minimum $\frac{3}{4}$ " thick. 1 x 3 strapping is recommended.
2. Wood Strapping Location:
Place vertically or horizontally, as required, and should be spaced a maximum of 16" on center. If placing vertically, align the strapping to the framing studs.
3. Fastener Types:
Use #8 or #10 non-corrosive wood screws spaced maximum 16" on center.
4. Fastener Length:
Screws should be long enough to penetrate wood strapping, Exterra, and at least 1" into the framing studs.
5. Attach cladding to wood strapping. Ensure the nails or screws fully penetrate the strapping.



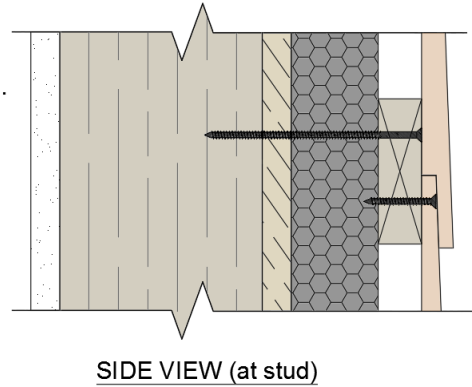
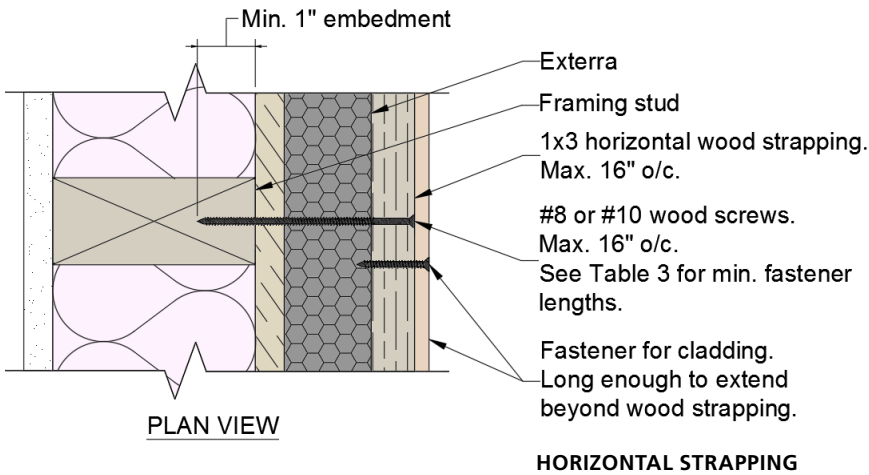
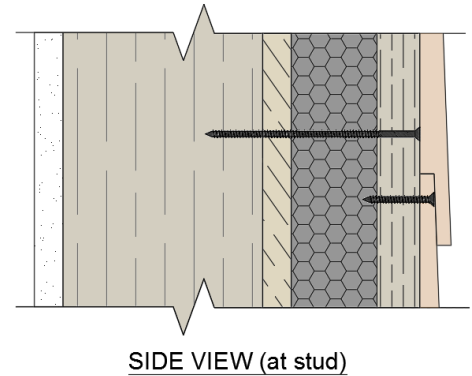
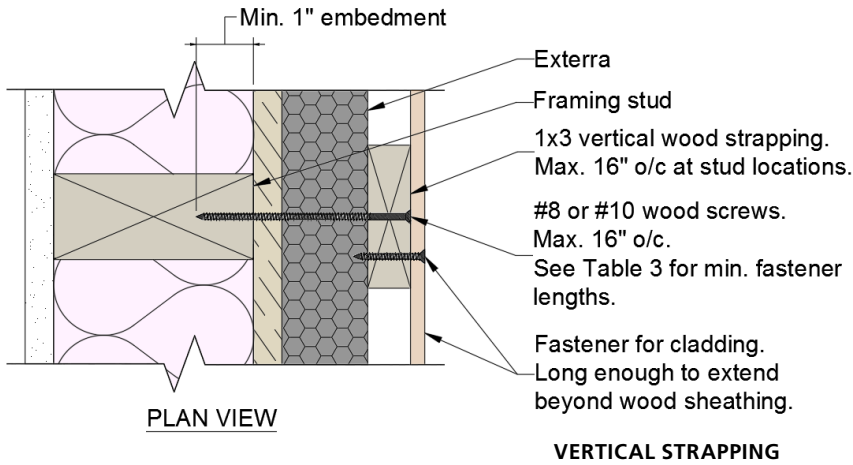

Table 3: 1x3 Wood Strapping Over Exterra

Exterra Thickness	Minimum Fastener Lengths		
	1/2" Wood Sheathing	5/8" Wood Sheathing	3/4" Wood Sheathing
9/16" or 5/8"	2 7/8"	3"	3 1/8"
1"	3 1/4"	3 3/8"	3 1/2"
1 1/2"	3 3/4"	3 7/8"	4"
2"	4 1/4"	4 3/8"	4 1/2"

9.0 - AIR BARRIER

Exterra wall assemblies require a separate air barrier system. The air barrier system can be from the exterior, interior, or anywhere in between as long as the continuity of the air barrier system is maintained.

Since 6 mil polyethylene membranes are typically required as the controlling vapor barrier for exterior wall assemblies, it can also provide the controlling air barrier. The following illustrations are examples of a polyethylene air barrier approach for Exterra wall assemblies. Careful attention should be paid to transitions and penetrations.

9.1 - ROOF/CEILING TRANSITION

Lap the 6 mil poly membranes in the ceiling and walls with vapor barrier sheathing tape.

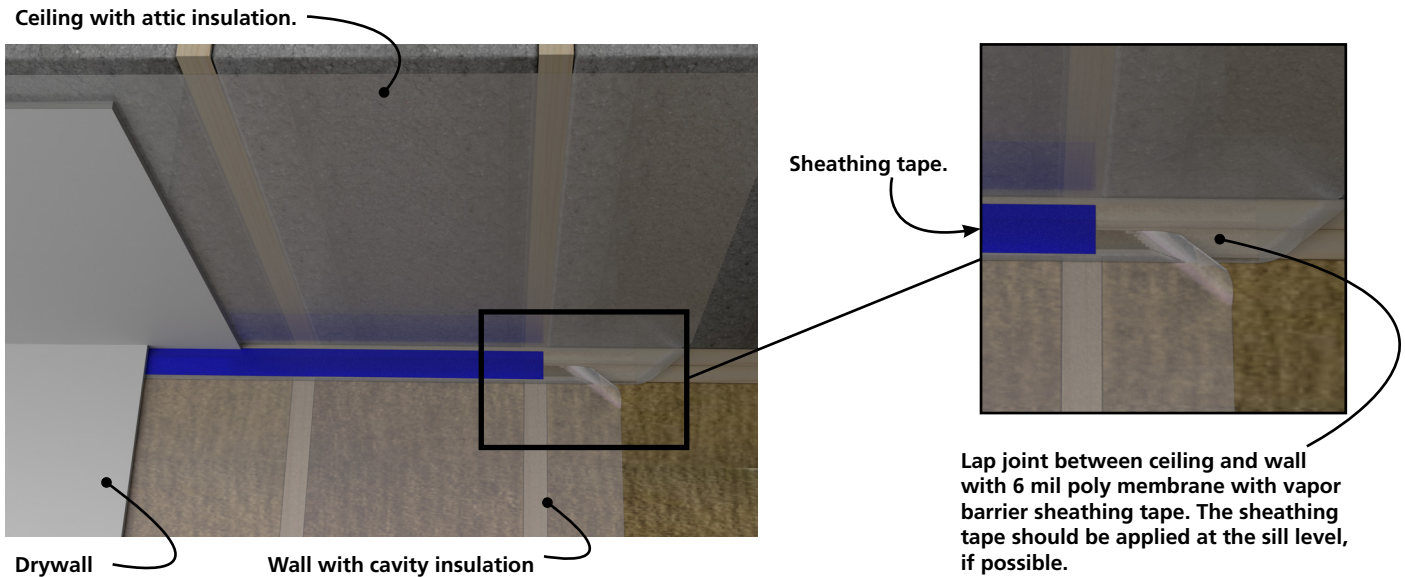

9.2 - WALL PERIMETER AND RIM BOARDS

Seal the 6 mil poly membrane to the framing members. Install rigid insulation against the rim board between floor joists. The insulation should be sealed to maintain the air barrier, and thick enough to act as a vapor/air barrier.

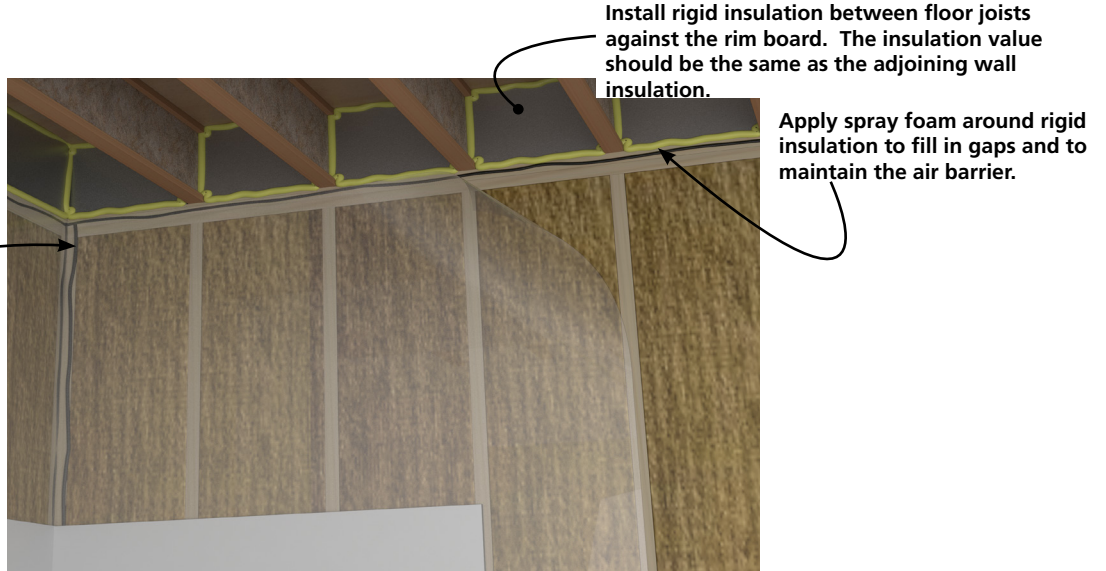

9.3 - FOUNDATION

Install rigid insulation against the rim board between floor joists. The insulation should be sealed to maintain the air barrier. A sealant should also be applied between the sill and top of foundation wall.

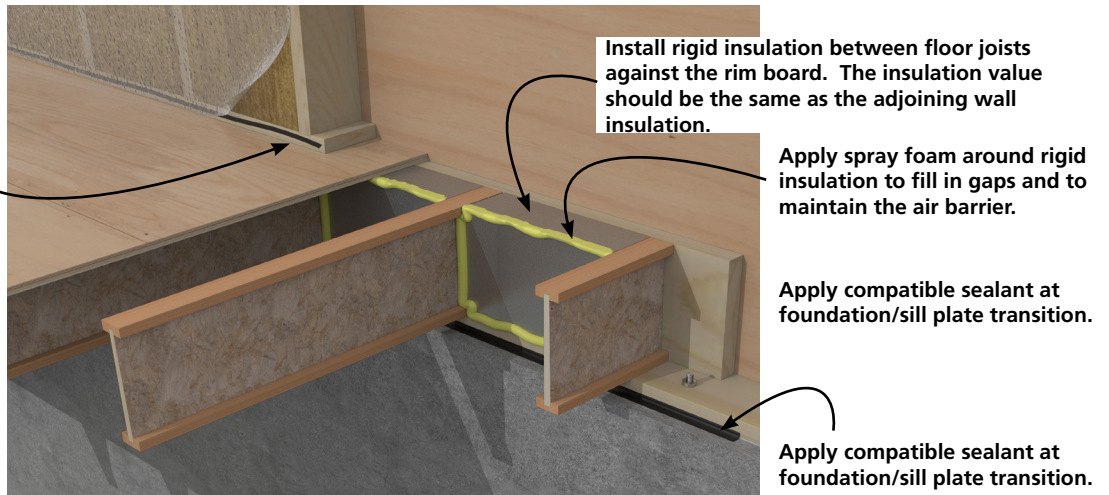

9.4 - PENETRATIONS

Providing a section of plywood sheathing around the penetration provides the required solid backing for 6 mil poly members.

Attached a section of wood sheathing. Fasten to blocking and keep flush to face of studs.

This will provide a solid backing for the 6 mil poly around the opening and secures the duct, pipe or conduit in place when connecting additional sections.

6 mil poly membrane (partially shown).

Place over the acoustic sealant and staple in place. Staples should be applied over the acoustic sealant.

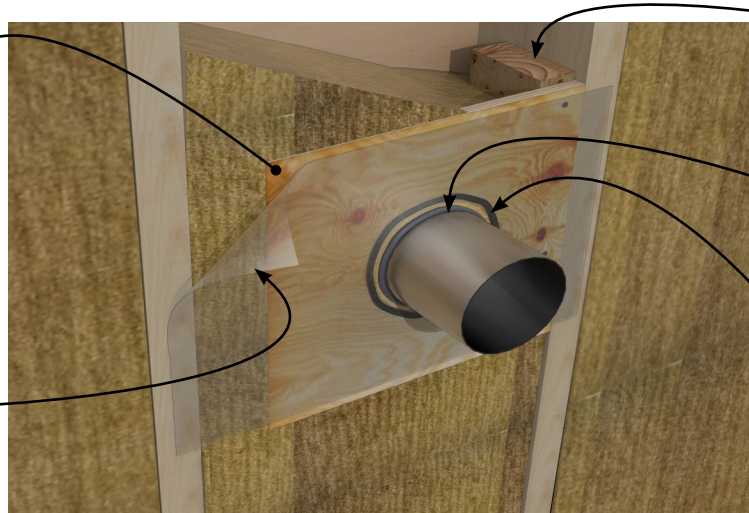

Wood blocking.

Compatible air barrier sealant applied around the duct, pipe or conduit.

Acoustic sealant.

9.5 - INTERIOR ELECTRICAL RECEPTACLES

Vapor/air barrier polyethylene boots should be used to maintain the air barrier around electrical receptacles.

Fasten wood blocking to stud. This will provide a solid backing for the vapor barrier boot.

6 mil poly membrane (partially shown).

Place over the acoustic sealant and staple in place. Staples should be applied over the acoustic sealant.

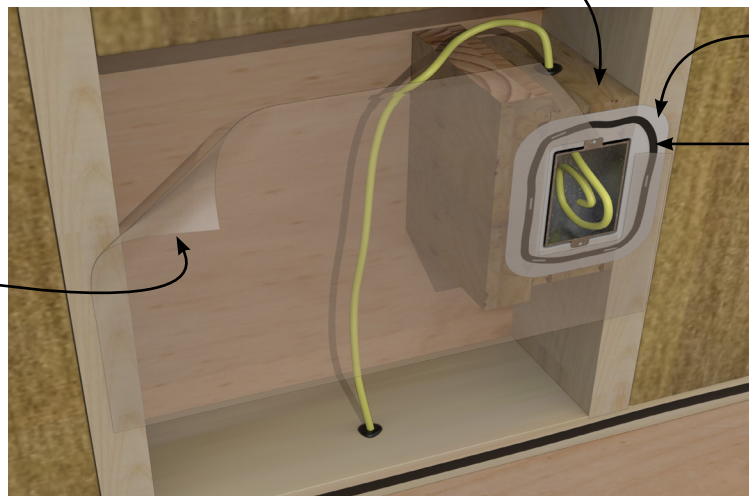

Vapor/air barrier boot.

Apply acoustic sealant around the vapor/air barrier boot.

10.0 - EXAMPLE CAD DETAILS

THE DRAWINGS REPRESENTED HEREIN ARE BELIEVED TO BE ACCURATE AND CONFORMING TO CURRENT DESIGN AND CONSTRUCTION PRACTICES. HOWEVER, THE DRAWINGS SHOULD BE USED AS A REFERENCE GUIDE ONLY. THE USER SHALL CHECK TO ENSURE THE DRAWING MEETS LOCAL BUILDING CODES, DESIGN AND CONSTRUCTION PRACTICES BY CONSULTING LOCAL BUILDING OFFICIALS AND PROFESSIONALS, INCLUDING ANY ADDITIONAL REQUIREMENTS. HALO RESERVES THE RIGHT TO MAKE CHANGES TO THE DRAWINGS WITHOUT NOTICE AND ASSUMES NO LIABILITY IN CONNECTION WITH THE USE OF THE DRAWINGS INCLUDING MODIFICATION, COPYING OR DISTRIBUTION.



HALO® EXTERRA® EXTERIOR RIGID INSULATION

10.1 - FLANGED WINDOW INSTALLED AGAINST WOOD SHEATHING

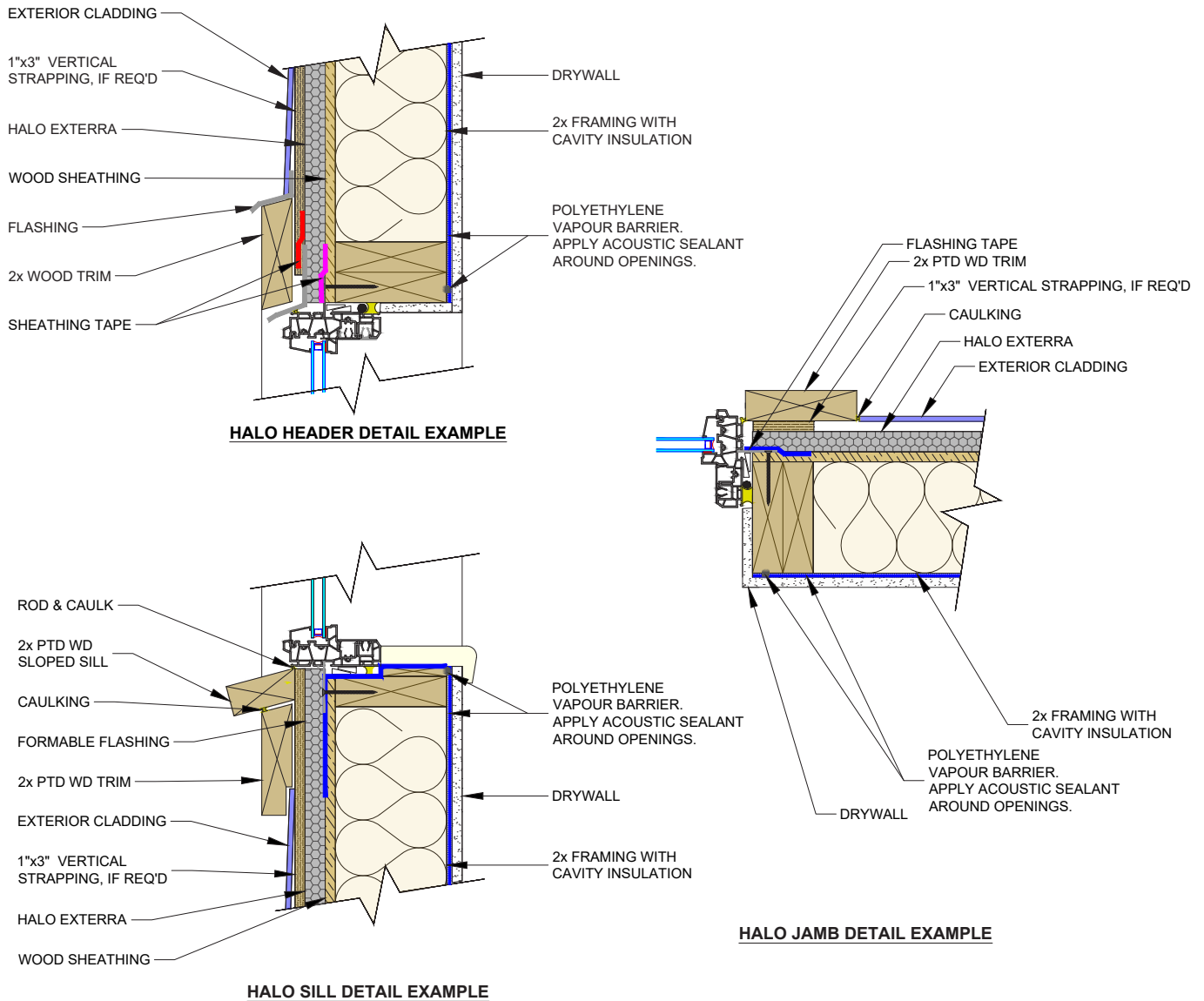

INSTALLATION GUIDE

The tables and drawings represented herein are believed to be accurate and conforming to current design and construction practices. However, the tables and drawings should be used as a reference guide only. The user shall check to ensure the drawing meets local building codes, design and construction practices by consulting local building officials and professionals, including any additional requirements. Logix reserves the right to make changes to the tables and drawings without notice and assumes no liability in connection with the use of the tables and drawings including modification, copying or distribution.



HALO® EXTERRA® EXTERIOR RIGID INSULATION

10.2 - FLANGED WINDOW INSTALLED AGAINST EXTERRA

INSTALLATION GUIDE

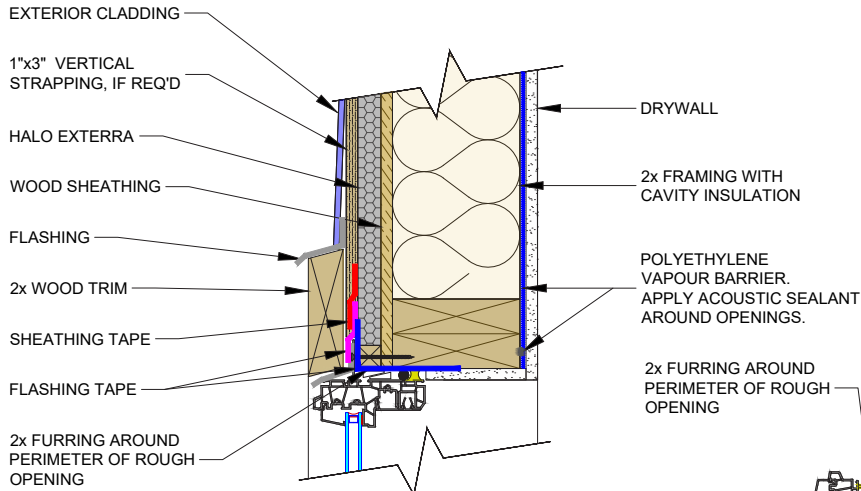

HALO HEADER DETAIL EXAMPLE

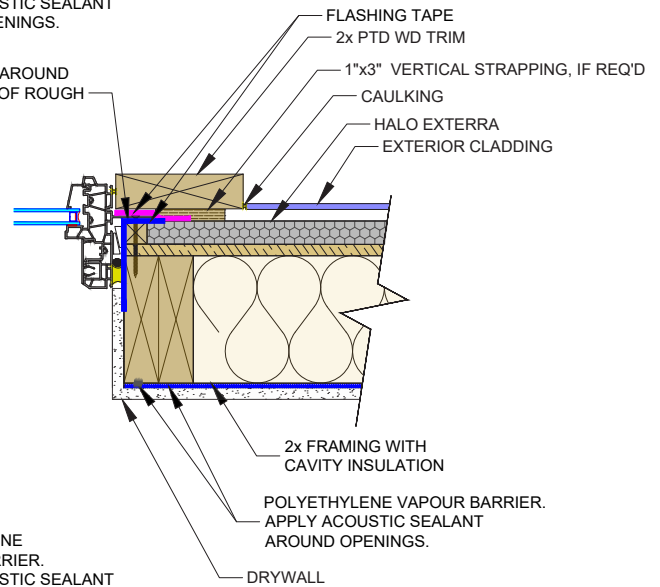

HALO JAMB DETAIL EXAMPLE

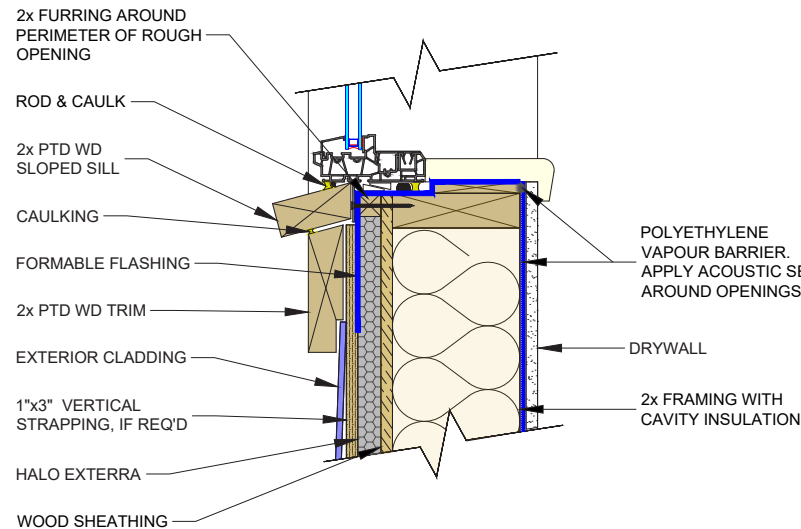

HALO SILL DETAIL EXAMPLE

The tables and drawings represented herein are believed to be accurate and conforming to current design and construction practices. However, the tables and drawings should be used as a reference guide only. The user shall check to ensure the drawing meets local building codes, design and construction practices by consulting local building officials and professionals, including any additional requirements. Logix reserves the right to make changes to the tables and drawings without notice and assumes no liability in connection with the use of the tables and drawings including modification, copying or distribution.



HALO® EXTERRA® EXTERIOR RIGID INSULATION

10.3 - ROOF TRANSITION

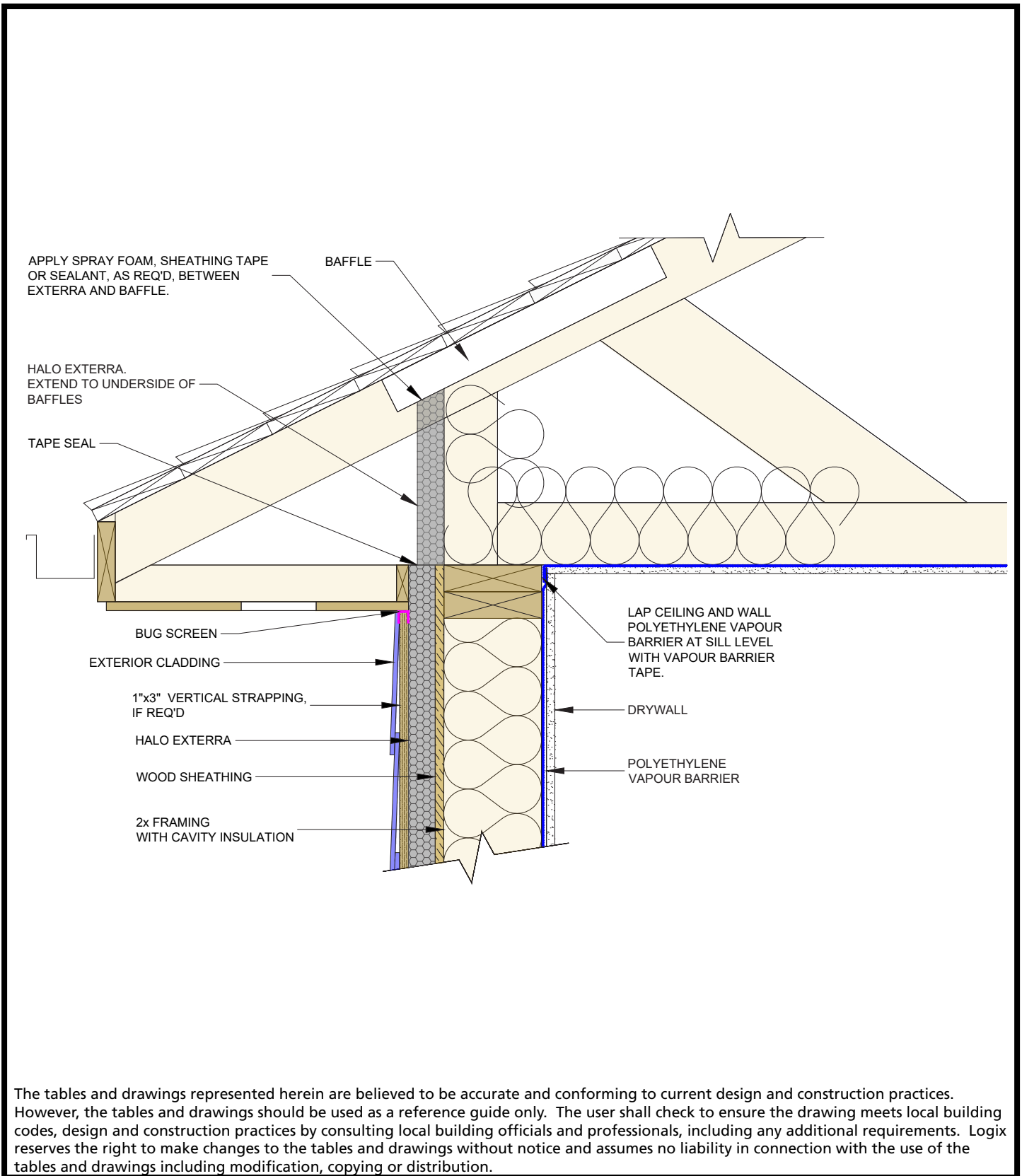

HALO® EXTERRA® EXTERIOR RIGID INSULATION

10.4 - TYPICAL WALL ASSEMBLY

INSTALLATION GUIDE

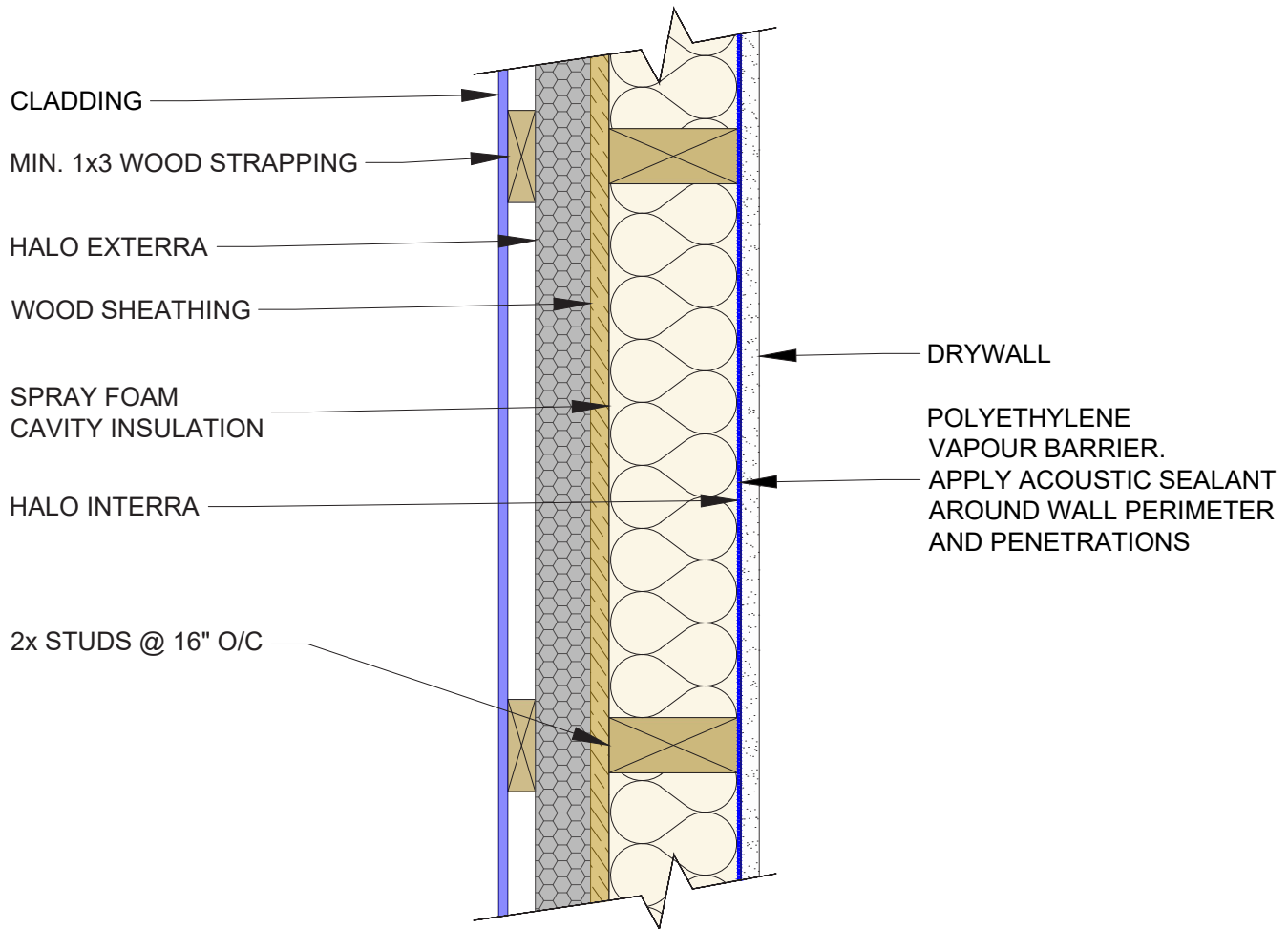

The tables and drawings represented herein are believed to be accurate and conforming to current design and construction practices. However, the tables and drawings should be used as a reference guide only. The user shall check to ensure the drawing meets local building codes, design and construction practices by consulting local building officials and professionals, including any additional requirements. Logix reserves the right to make changes to the tables and drawings without notice and assumes no liability in connection with the use of the tables and drawings including modification, copying or distribution.



HALO® EXTERRA® EXTERIOR RIGID INSULATION

10.5 - FLOOR TRANSITION

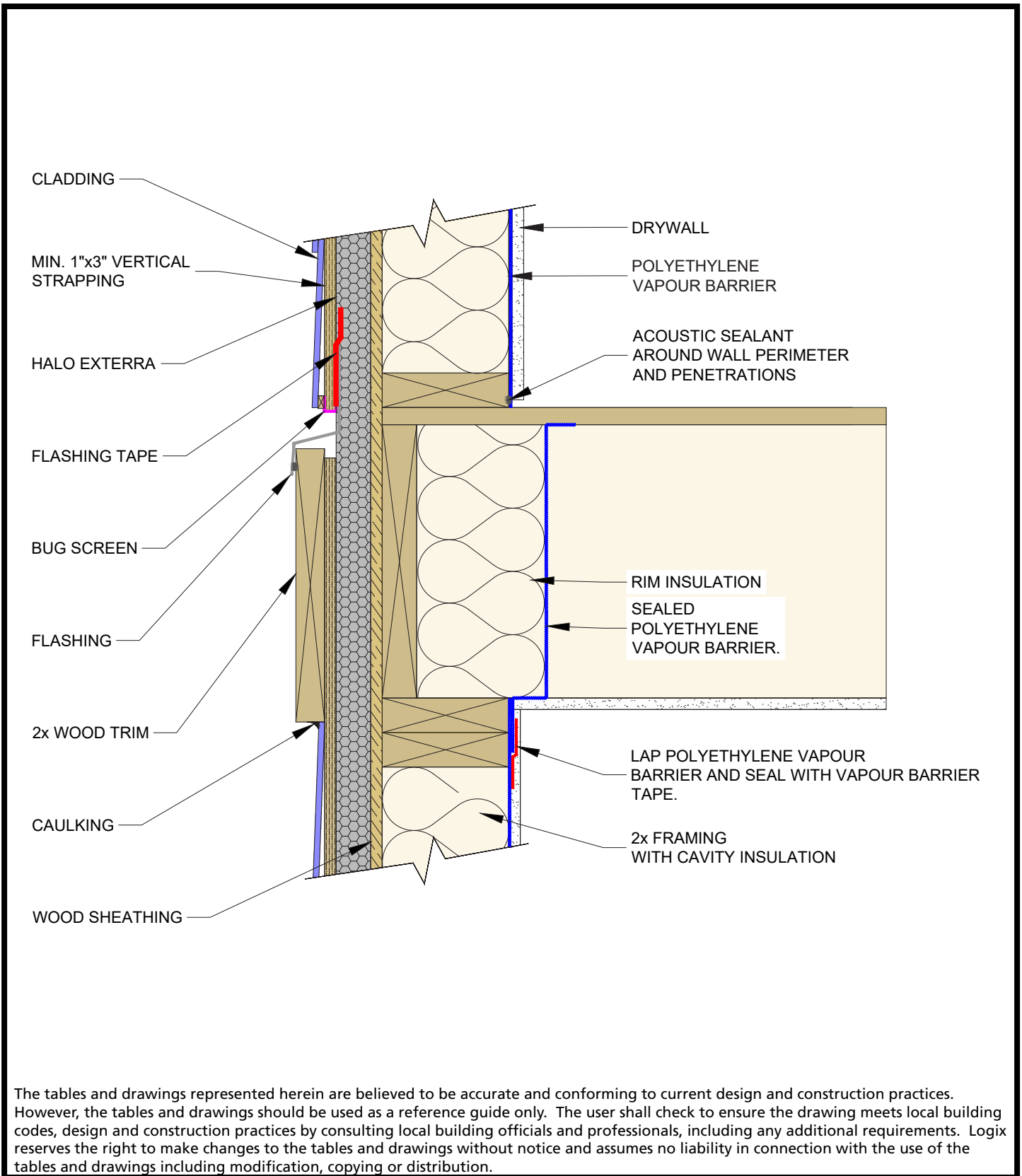

INSTALLATION GUIDE

The tables and drawings represented herein are believed to be accurate and conforming to current design and construction practices. However, the tables and drawings should be used as a reference guide only. The user shall check to ensure the drawing meets local building codes, design and construction practices by consulting local building officials and professionals, including any additional requirements. Logix reserves the right to make changes to the tables and drawings without notice and assumes no liability in connection with the use of the tables and drawings including modification, copying or distribution.



HALO® EXTERRA® EXTERIOR RIGID INSULATION

10.6 - FOUNDATION TRANSITION

INSTALLATION GUIDE

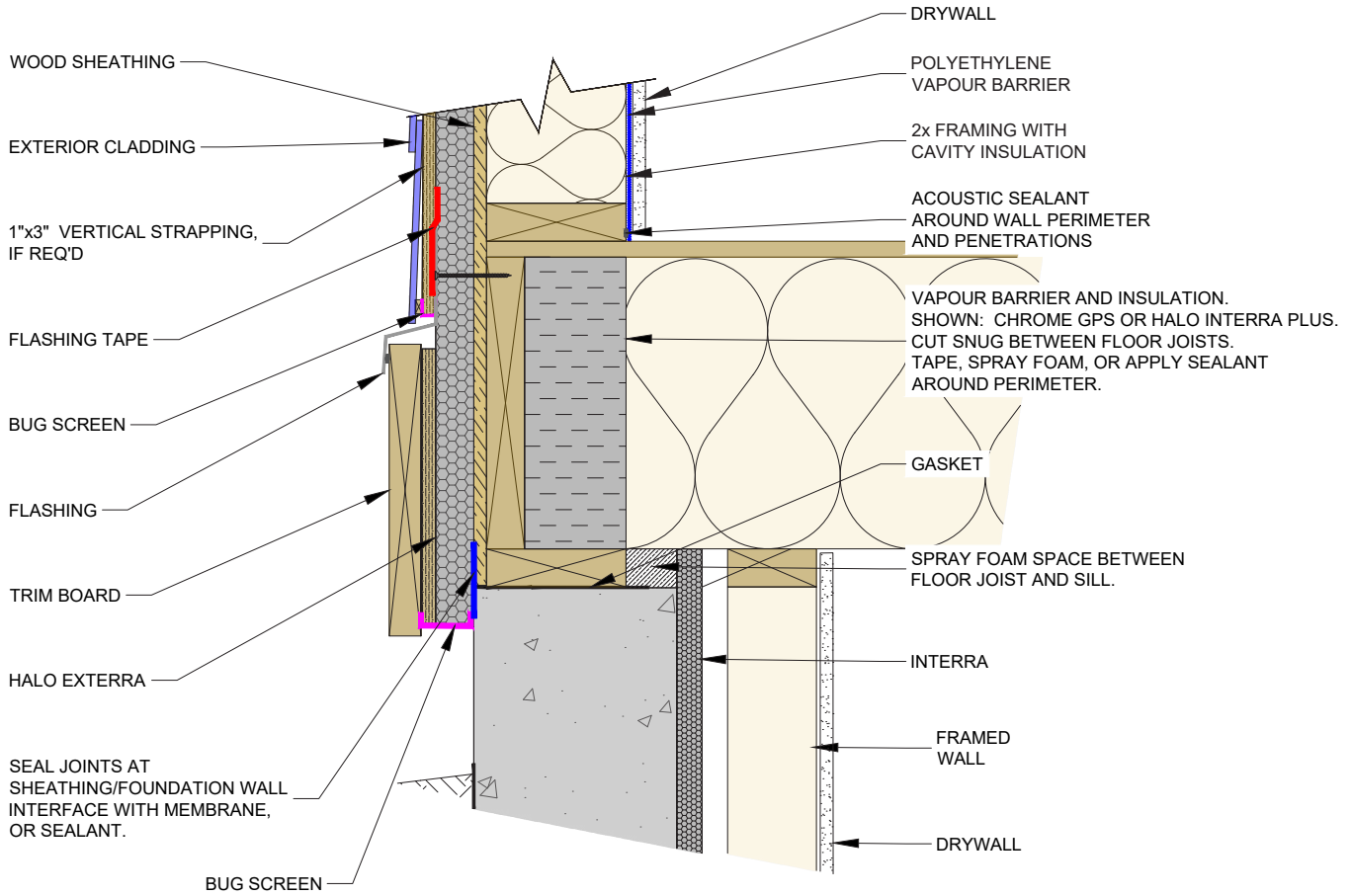

The tables and drawings represented herein are believed to be accurate and conforming to current design and construction practices. However, the tables and drawings should be used as a reference guide only. The user shall check to ensure the drawing meets local building codes, design and construction practices by consulting local building officials and professionals, including any additional requirements. Logix reserves the right to make changes to the tables and drawings without notice and assumes no liability in connection with the use of the tables and drawings including modification, copying or distribution.





CONNECT WITH A LOCAL MANUFACTURER

888.838.5038
330 Cain Drive
Haysville, KS 67060-2004

800.860.3626
6753 Chestnut Ridge Rd.
Beach City, OH 44608

800.647.6130
2604 Sunset Dr.
Grenada, MS 38901

800.647.6130
106 Perma R Rd.
Johnson City, TN 37604

877.789.7622
35 Headingley Rd.
Headingley, MB R4H 0A8

888.453.5961
11581-272 St.
Acheson, AB T7X 6E9

888.453.5961
#215-44393 Simpson Rd.
Chilliwack, BC V2R 5M3

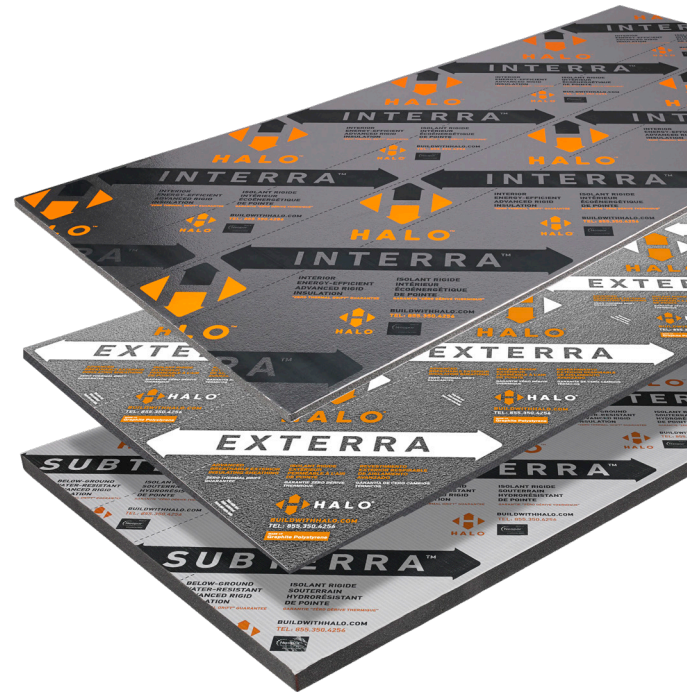

HALO[®]
ADVANCED GRAPHITE INSULATION SYSTEM

855-350-4256 (Halo)
info@BuildWithHalo.com
BuildWithHalo.com

A PRODUCT BY
LOGIX[®]
BRANDS